

VERICUT[®]

Right the first time. Every time.

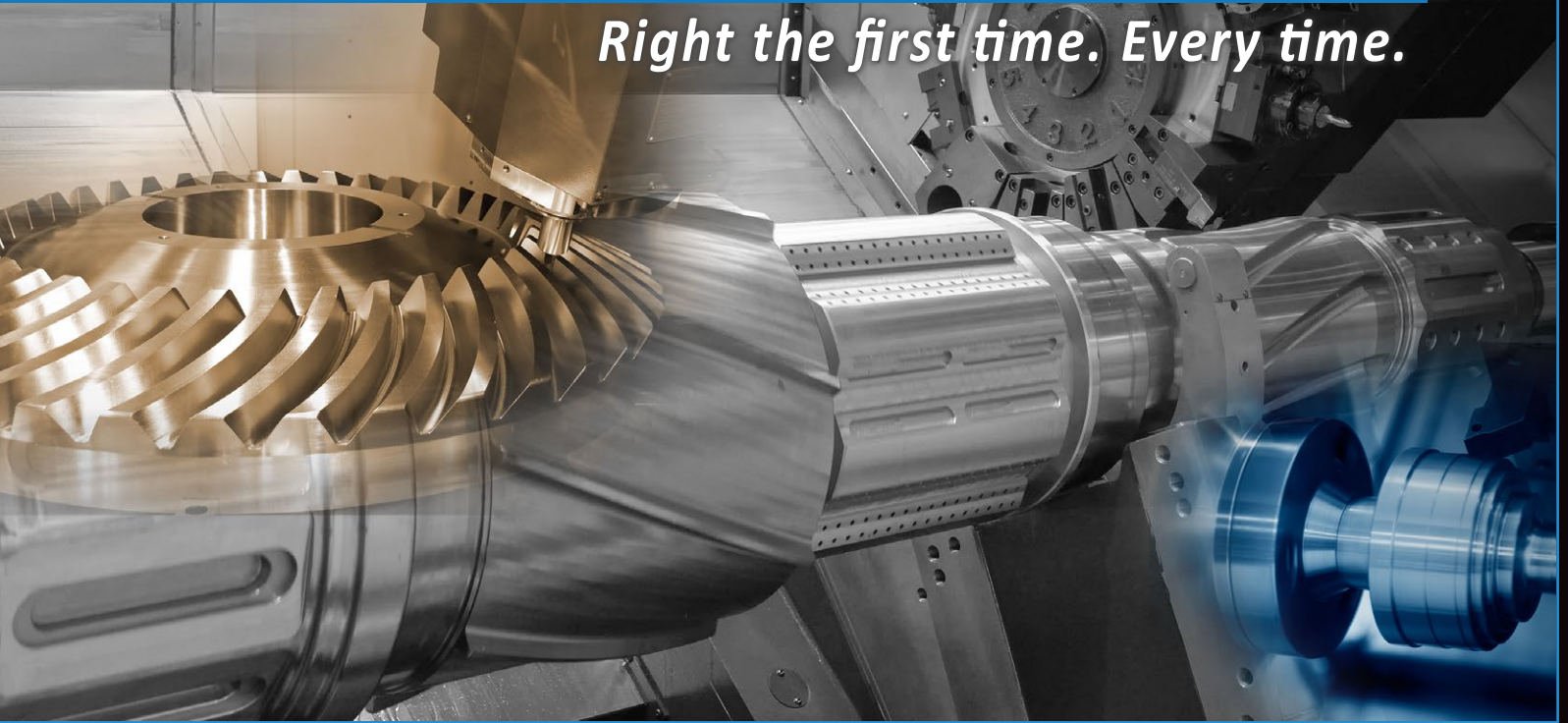

CNC Machine
Simulation



NC Program
Verification



Cutting Speed
Optimization



Composite
Applications



Drilling &
Fastening

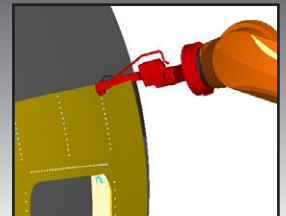
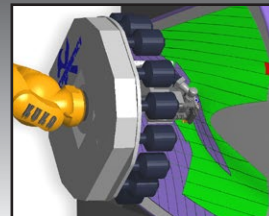
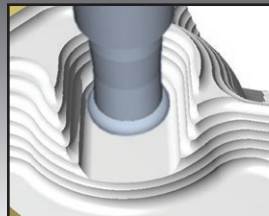
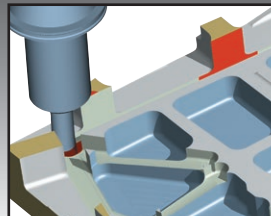
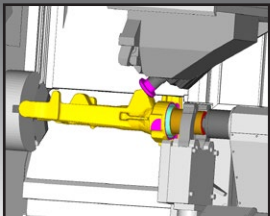

“*VERICUT is a non-biased checking mechanism of the post-processed code from both of our CAM systems. Our policy is that no program can go to the floor unless it has gone through VERICUT.*”

*Frank Dorsey, Engineering Manager
Ellanef Manufacturing Corporation
A Subsidiary of Magellan Aerospace USA, Inc.*

CGTECH.com

Go ahead...

CRASH Your Machine!

...as long as it's in VERICUT

A crash on a VERICUT "virtual machine" can save your real machine!

VERICUT CNC simulation software enables you to machine parts on the computer before actual cutting occurs so you can eliminate errors that could ruin the part, damage the fixture, break the cutting tool, or crash the machine.

VERICUT also optimizes the cutting process to make your programs fast and efficient. And, VERICUT offers the best tools available for analyzing, inspecting, and using the in-process, "as-cut" model.

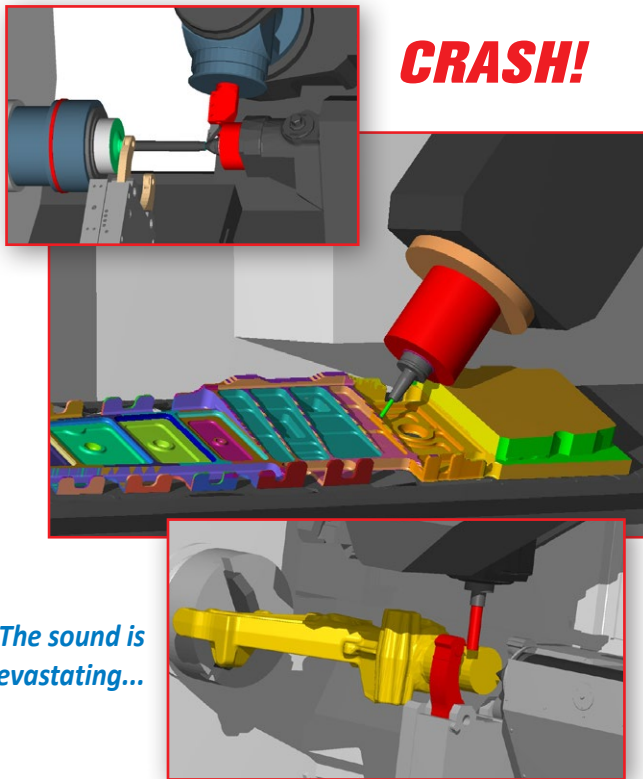

The sound is devastating...

A simple mistake can ruin your part, tool, machine, or even your machinist! And it can throw your production schedule into disarray.

If you use a CNC machine seriously, you should seriously consider VERICUT simulation!

A Little About CGTech

When you invest in VERICUT, you're not just buying a software program, you're teaming up with the largest group of CNC machining experts in the world. Features and benefits of working with us include:

- ✓ Our products, including VERICUT simulation technology, are developed in-house by CGTech engineers. This allows for quick changes and specific customization by the original developers.
- ✓ CGTech enjoys very high retention of its sales, customer support engineers, and resellers. This provides consistent and experienced contacts for a long-term business relationship with your company.
- ✓ Your CGTech contacts work closely with VERICUT developers to best support your needs.
- ✓ CGTech has been a stable and consistently profitable business, owned and managed by the original founders since 1988.
- ✓ CGTech is privately held and 100% self-financed, allowing us to plan long-term without concern of investors, stock price, or parent company pressure.
- ✓ A large pool of trained VERICUT users exists in virtually every industrialized country (tens of thousands of seats sold).
- ✓ We have seen most of the challenges manufacturers face. We are continually exposed to new manufacturing methods and technologies worldwide, and can quickly react to ever-changing industry needs.
- ✓ As an approved vendor/product at most major companies around the world, CGTech is a reliable partner for your NC manufacturing operations.

VERICUT®

CAD/CAM, Tooling, & Model Interfaces

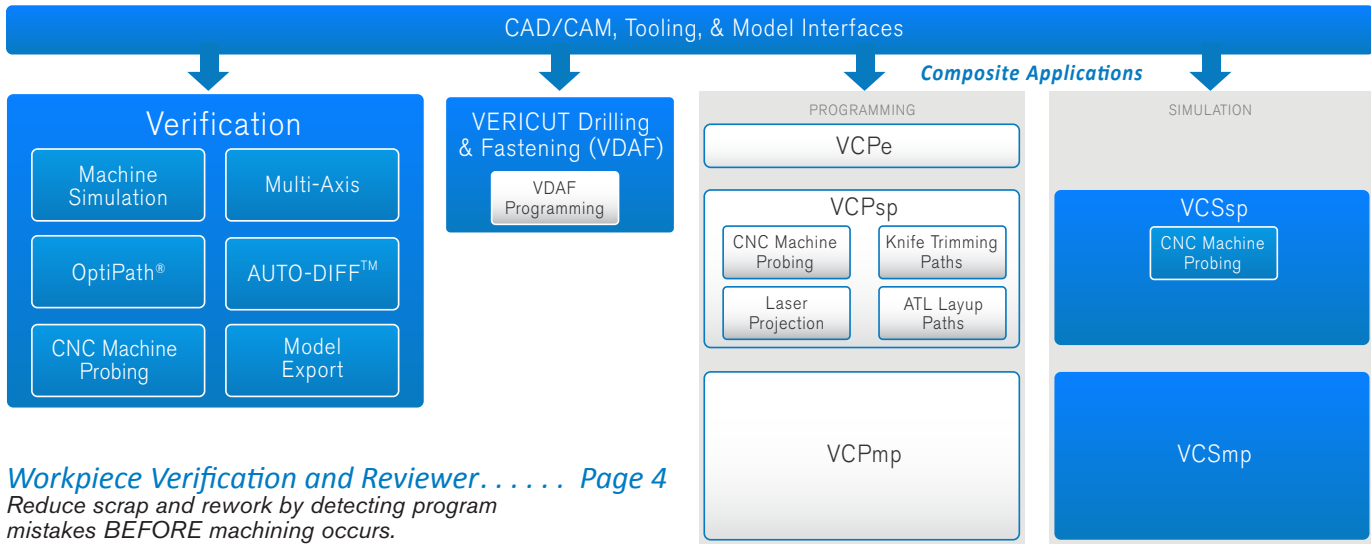

Workpiece Verification and Review..... Page 4

Reduce scrap and rework by detecting program mistakes BEFORE machining occurs.

Reports, Multi-Axis, and AUTO-DIFF..... 5

Generate in-process inspection instructions and other documentation from in-process machined features. Compare the cut stock to the design model.

CNC Machine Simulation..... 6

Simulate your CNC machine, exactly as it behaves on the shop floor, to detect potential problems before the program goes to the shop floor.

CNC Program Optimization..... 8

Automatically modify feed rates to make your programs more efficient.

CNC Probe Programs..... 10

Create and simulate CNC probe programs.

CAD Model Export..... 11

Create a CAD model from an existing NC program, at any stage of machining.

Interfaces to VERICUT..... 12

Seamlessly integrate VERICUT with your CAM system or tool management software.

Implementation Advice..... 13

Get the most from your VERICUT purchase.

Training & Services..... 14

Team up with CGTech manufacturing experts committed to helping you succeed.

Drilling & Fastening..... 16

Program and simulate your automated drilling & fastening machines.

Composite Applications..... 18

Program and simulate your automated fiber-placement and tape-laying CNC machines.

VERICUT's modular format provides flexibility – you purchase only the capabilities you need. It's easy to add modules; just let us know and we provide a license that gives you immediate access. VERICUT runs on Windows platforms. VERICUT is delivered as both a 32 bit and 64 bit application. G-codes and CAM center-line (CL) formats are supported.

“VERICUT paid for itself the first time we used it.”

Dave Watson, Manufacturing Eng.
Lockheed Martin
Aeronautical Systems

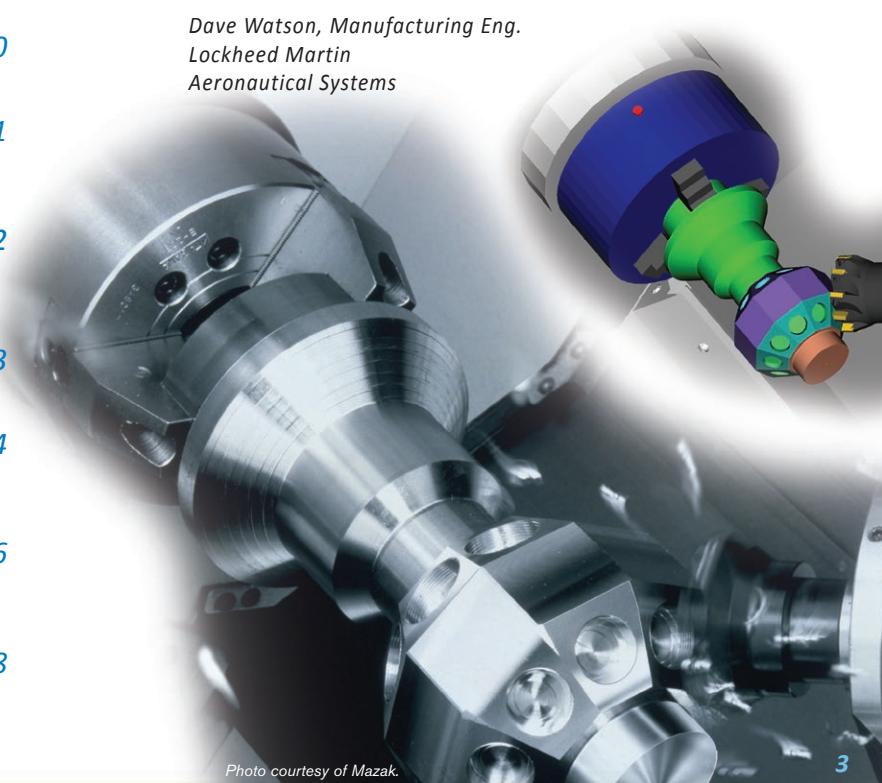
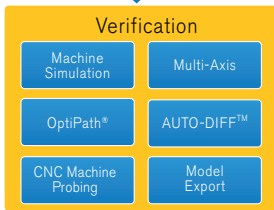
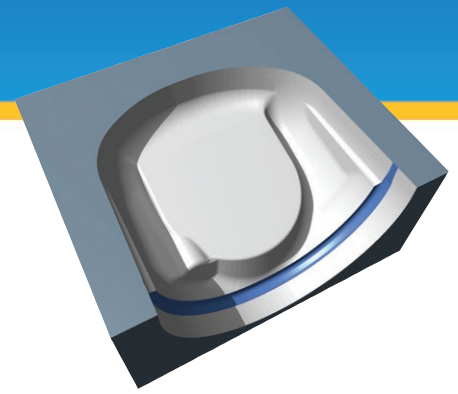

Photo courtesy of Mazak.

CAD/CAM, Tooling, & Model Interfaces



Workpiece Verification



Easily detect program mistakes and verify part accuracy with the VERICUT base module: Verification.

Superior Performance:

VERICUT's unique algorithm provides fast, accurate results. Performance does not degrade with increased cuts, so VERICUT can process programs with millions of cuts and virtually any type of material removal technique.

Machining Support:

- 3-axis milling; 2-axis turning
- Rotary 5-axis positioning. Add our **Multi-Axis** module to detect collisions during positioning and to remove material during continuous four and 5-axis milling, drilling, turning, and combination mill/turn operations.
- EDM Die Sinking
- Multiple simultaneous cutting tools
- Multiple setups or operations

The Project Tree allows you to view and configure all setups for a job. Each setup has its own CNC machine, fixtures, tools, NC programs, and simulation settings. The cut stock automatically orients as it moves from setup to setup.

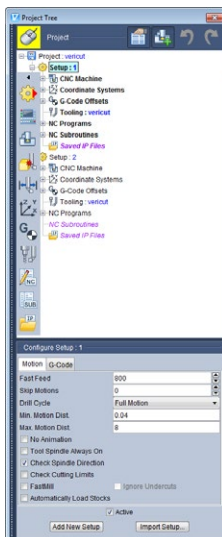

Control Support:

Verification supports most common control functions, and controls are easily modified.

- Rotary axis pivot points
- Look-ahead cutter compensation
- Supports several different tool length compensation methods
- Control cycles; fixture offsets
- Variables, subroutines, macros, looping, branching logic

Inspection and Measurement:

- Zoom, reverse, rotate, cross-section the cut stock
- Measure thickness, volume, depth, gaps, distances, angles, hole diameters, corner radii, scallop heights, etc.

Other Capabilities:

- Video and image capture
- Create a custom user interface for specific applications
- Add previously removed material back to the cut stock when stepping back in Review Mode

Included Analysis Tools

The base Verification module enables you to view and analyze the geometry of the cut part. Models can be cross-sectioned multiple times at any orientation, so you can check areas that would be impossible to see in a solid model (such as the intersection of drilled holes).

The X-Caliper™ tool measures thickness, volume, depth, gaps, distances, angles, hole diameters, tapping features, corner radii, scallop height, edges, and more. Delta X, Y, Z component distance measurements are included. X-Caliper also allows you to optionally highlight features, such as all planes on the same level. You can view and measure all tool collisions, even after subsequent machining operations have removed them from the screen.

VERICUT Reviewer

With VERICUT Reviewer shop floor personnel, suppliers, customers, and other production engineers can view animations of the CNC machining process. VERICUT Reviewer incorporates all the functionality of NC Review Mode in a stand-alone viewer that does not use a license. Reviewer can play forward and backward while removing and replacing material. You can rotate, pan and zoom

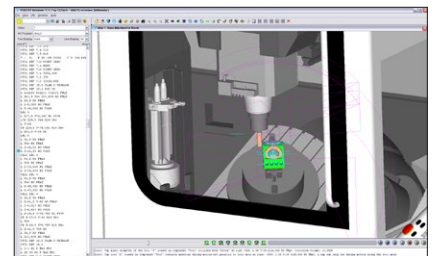

just like normal VERICUT, and the cut stock can be measured using all the standard X-Caliper tools. The "Reviewer" file can be saved at any point in a VERICUT session.

Inspection Reports & Setup Plans
Save time and improve accuracy by generating in-process inspection instructions and other documentation from VERICUT's simulated in-process machined features!

With VERICUT, you can establish a formal, but simple and efficient method to create and document inspection and setup procedures.

All VERICUT reports are customizable using a simple template. When modifying a template, a preview window shows exactly how the finished

report will display. Creating the report is quick and easy because you use the in-process model to graphically select features.

For inspection reports, VERICUT identifies the feature, extracts feature sizes, and applies a standard tolerance for the measurement. You can then add any additional instructions and select the measuring instrument from a list. The setup plan feature allows you to add simple dimensions and notes to a VERICUT image that can then be added to a

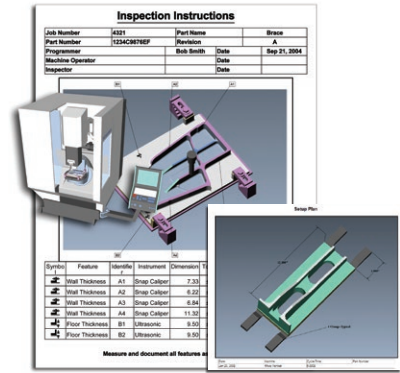

VERICUT report. All VERICUT reports can be saved in standard HTML or PDF formats.

Multi-Axis

As complexity of the part and the machining operation increases, so does the chance for error. Don't leave the accuracy of the NC program, the quality of the part, or the safety of the operator to chance! The Multi-Axis module verifies and simulates material removal during:

- Multi-axis milling (i.e. cutting with a changing tool axis)
- Synchronized motion of multiple independent cutting heads or attachments such as 4-axis lathes/mill-turns or multiple-head machines

CAD/CAM, Tooling, & Model Interfaces

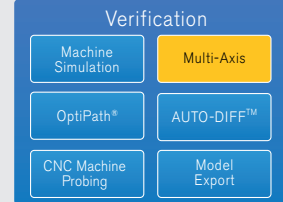

CAD/CAM, Tooling, & Model Interfaces

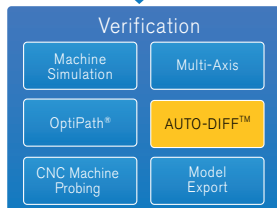

AUTO-DIFF

Detect gouges and excess material by comparing the design model to the "as-machined" model.

Different colors can be assigned to the design model, rough stock, errors, gouges, collisions, or excess material for easy identification. The Surface Range tables include a value to represent surface cuts exactly matching the design model.

By the time a part design is ready to be machined, it may have passed through several engineers/programmers, departments, companies, and CAD/CAM systems. In the end, it can be difficult to tell whether the tool path accurately represents the intended design. With AUTO-DIFF, you can be sure.

The design model can be a solid, surface, skin, or points. You can "embed" the design model inside the rough material for interactive gouge-checking. If the tool contacts the design, VERICUT highlights the gouge and records the error. The design model even moves with the cut stock as it transitions between setups.

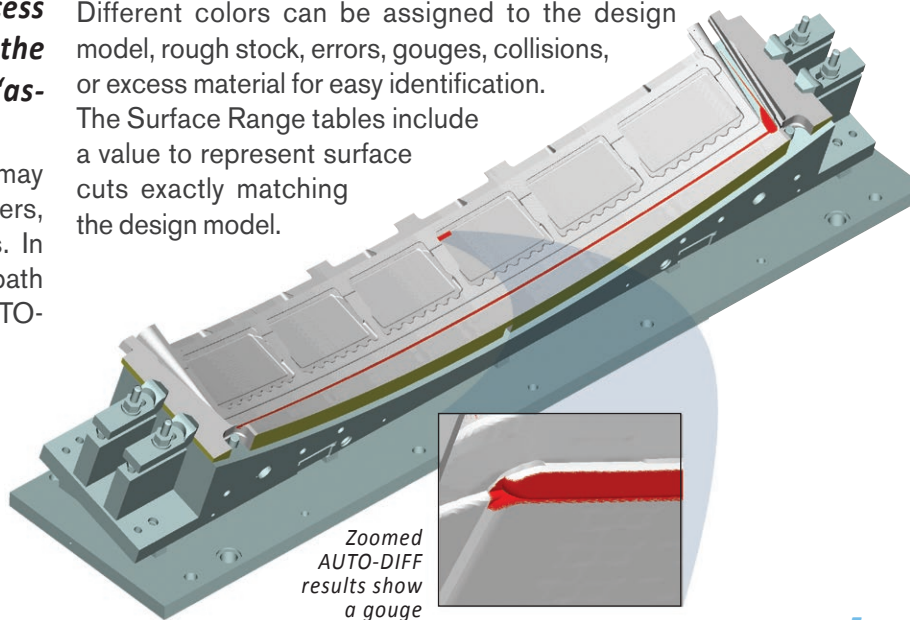

Machine Simulation

CAD/CAM, Tooling, & Model Interfaces

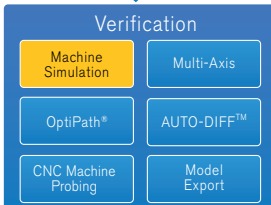

No more expensive surprises! Simulate your CNC machines, exactly as they behave on the shop floor, so you can detect errors and potential problems before the program goes out to the shop!



A machine crash can be very expensive, potentially ruin the machine, and delay your entire manufacturing schedule! But with VERICUT, you can dramatically reduce the chance for error and avoid wasting valuable production time proving-out new programs on the machine.

Machine Simulation detects collisions and near-misses between all machine tool components such as axis slides, heads, turrets, rotary tables, spindles, tool changers, fixtures, work pieces, cutting tools, and other user-defined objects. You can also set up “near-

miss zones” around the components to check for close calls, and detect over-travel errors. Machine movements can even be simulated while stepping or playing backwards in VERICUT’s Review Mode.

A selection of customizable machine models are included. Or, you can build models from scratch. Machine components can be designed in a CAD system or defined in VERICUT. A “Component Tree” feature makes it easy to connect the machine’s pieces and manage the kinematics of the machine.

Machine Simulation Supports:

- Multi-axis milling, drilling, turning, mill-turn, EDM
- Simultaneous mill/turn on different spindles and workpieces
- Machines with multiple synchronized CNC controls
- Auxiliary attachments: tail stock, steady rests, part catchers, bar pullers, pallet changers, etc
- Automatic workpiece transfer to pick-off or sub-spindles
- STEP, STL, IGES, and others.

Many sample machines and control configurations are included.

VERICUT’s MDI includes axis jog buttons and allows tool positioning by graphical picks. Using the simple MDI controls, you can make sure your machine can reach all the necessary features of the part.

Prevent CNC machine crashes and near-misses

Improve process efficiency

Reduce the time it takes to implement new CNC machines

Increase shop safety

Show machinists what to expect from new NC programs

Train programmers and machinists without using production time... or risking a crash

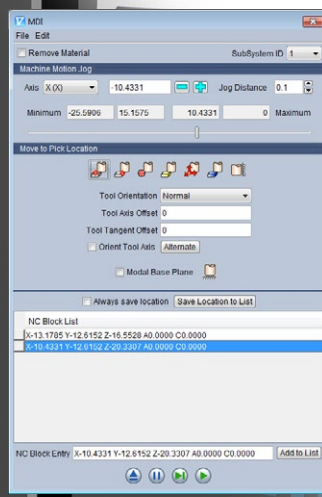
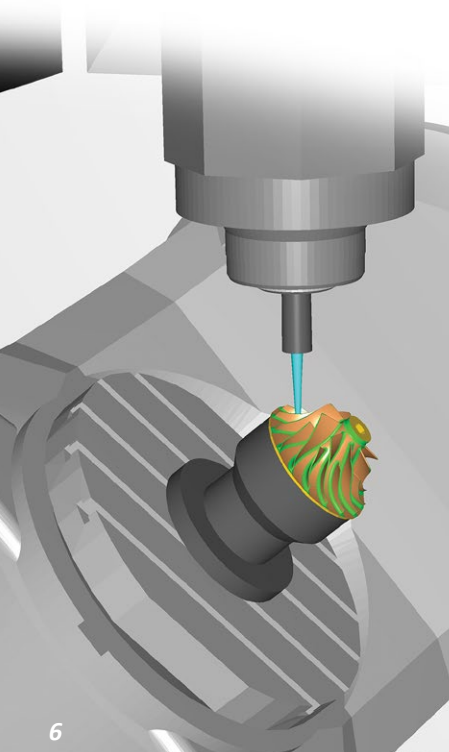

Cutter/Grinder Verification & Machine Simulation

Before you risk crashing the machine or destroying the grinding wheel, verify grinding operations in VERICUT and perform detailed analysis to make sure the part is correct before machining. Featuring an interface designed especially for grinding, verification and machine simulation can be launched from a grinder programming system (i.e. NUMROTOplus® or Schütte) to verify multi-axis grinding.

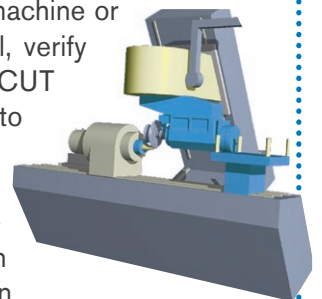

Superior Collision Checking

VERICUT features the most accurate collision-checking available. Rather than just checking points along a path, VERICUT checks along the entire path of travel by sweeping through space. You don't have to specify a "step size" tolerance that can slow the simulation if too small or miss the collision if too large!

Today's NC machine tools process complex NC programs. VERICUT was designed by NC programmers and professionals in NC simulation and verification software. Because of this expertise, VERICUT is an excellent tool when using multi-axis machines, complex NC code, and/or advanced programming techniques.

VERICUT is designed to support advanced control functions including:

- Look-ahead or 3D cutter compensation
- Tool tip programming & tool length compensation
- Gage length reference point programming
- Canned cycles and fixture offsets
- Rotary axis pivot points
- Variables, subprograms, and macros
- Subroutines, looping, and branching logic

VERICUT detects the collision!

Point-check methods can miss collisions!

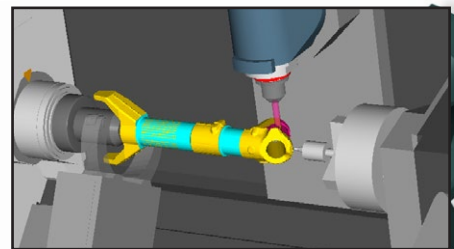
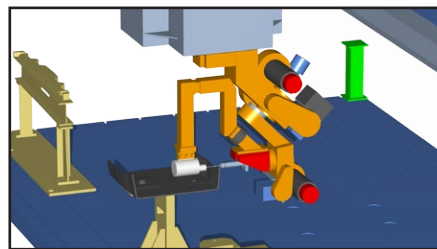
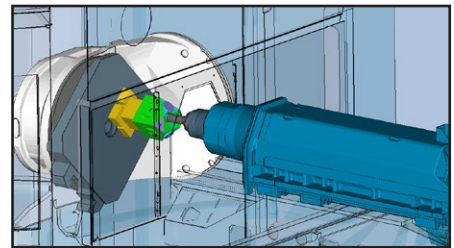
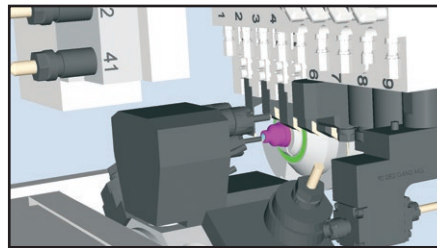
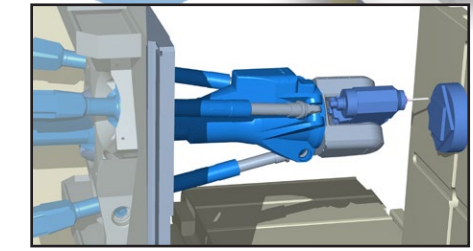
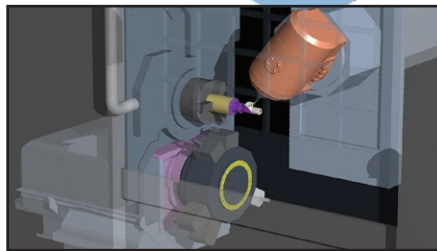

Tools to Simulate More Complex Applications...

VERICUT also supports:

- Automatic part transfer between fixtures
- Facing head (or "programmable boring bar")
- Mill/turn machining center's multi-channel programming/synchronization
- CNC controls which allow programming of the tool axis using IJK tool axis vectors
- Turning operations which are not symmetric about the lathe spindle
- Machines that use Parallel kinematics, such as the SMT Tricept head
- Multi-axis waterjet cutting operations
- Material removal for gear hobbing (synchronize spindles)

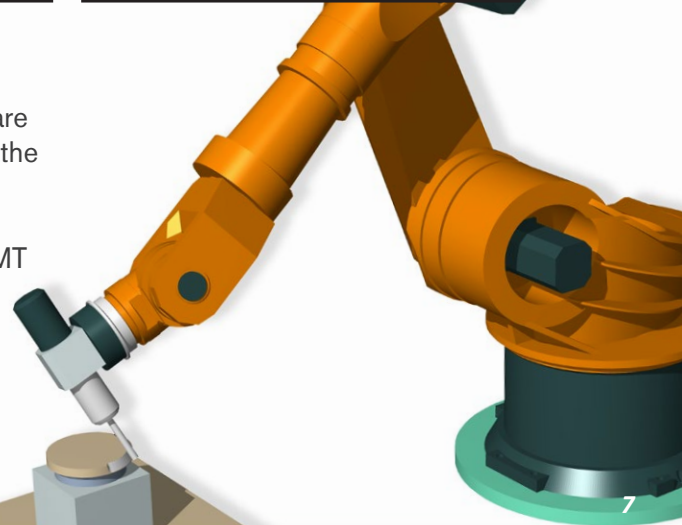

OptiPath Feed Rate Optimization

CAD/CAM, Tooling, & Model Interfaces

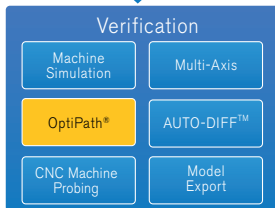

Cut parts faster, improve surface finish, & reduce tool wear without altering the path trajectory



OptiPath supports multi-axis machining!

VERICUT's optimization module, OptiPath®, automatically modifies feed rates based on the current cutting conditions to make your programs more efficient, while also extending tool life and improving surface finish!

Knowledge-Based Machining

VERICUT is a true knowledge-based machining system. Through the simulation process, it learns the exact depth, width, and angle of each cut. And it knows exactly how much material is removed by each cut segment. With that knowledge, OptiPath divides the motion into smaller segments. Where necessary, based on the amount of material removed in each segment, it assigns the best feed rate for each cutting condition

encountered. It then outputs a new tool path, identical to the original but with improved feed rates. It does not alter the route of the tool path.

Simplified Setup and Use

A setup wizard prompts you for cutter settings as you machine the part. Essentially, you add intelligence to the cutter. All the settings for that cutter are stored in an optimization library. You define the settings once. Every time you use that cutter the results can be instantly optimized!

OptiPath also features a "learn mode" for creating the optimization library with no setup required. For each tool, OptiPath finds the maximum volume removal rate and chip thickness and uses them to determine the optimization settings for the tool.

Adjust, test, and fine-tune your optimization settings as many times as you want without re-running the simulation. After running the simulation once, VERICUT stores all the cut information. You can interactively navigate, evaluate, and change the optimization settings individually on a cut-by-cut level. The results are displayed immediately.

Optimization for Roughing

During roughing, the goal is to remove as much material as quickly as possible. OptiPath keeps the cutter at

its maximum safe rate-of-advance into material for the varying cutting conditions. For example, during planar roughing of an aluminum aerospace structural component, material may be removed at a constant axial depth, but the radial width of cut could differ greatly from cut to cut. OptiPath modifies the feed rates to maintain a constant volume removal rate.

Optimization for Finishing

Chip loads typically vary widely as the tool profiles through the material left behind during roughing cuts. OptiPath adjusts the feed rates to maintain a constant chip load. (Constant chip loads are recommended by cutting tool makers to reduce "chip thinning.") The results are improved tool life and better surface finish. This is especially critical when tip cutting with a ball end mill or contouring a surface with a small step-over, such as semi-finishing or finishing in a tool steel mold cavity.

"4½ hours of programmer time spent on optimization saved us \$75,000!"

Brian Carlson
Programming Manager
Aerospace Dynamics,
International

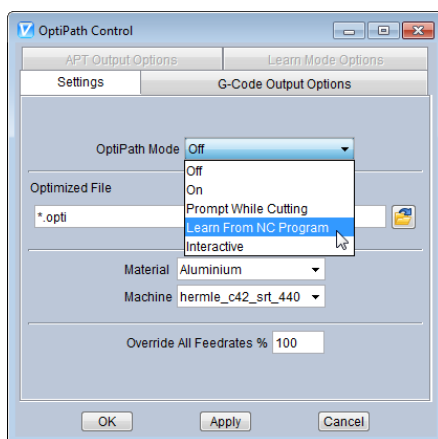

OptiPath features a "learn mode" for easy creation of optimized NC programs with no setup required.



How it Works...

As the cutting tool encounters more material, feed rates decrease. As less material is removed, the feed rates speed up accordingly. Based on the amount of material removed by each cut segment, OptiPath automatically calculates and inserts improved feed rates where necessary. Without changing the trajectory, OptiPath writes the updated feed rates to a new NC program.

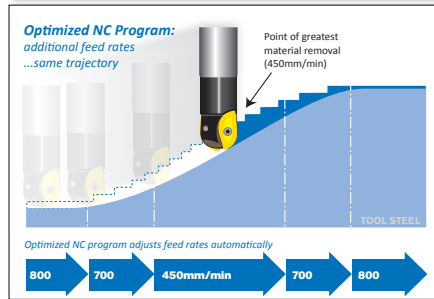
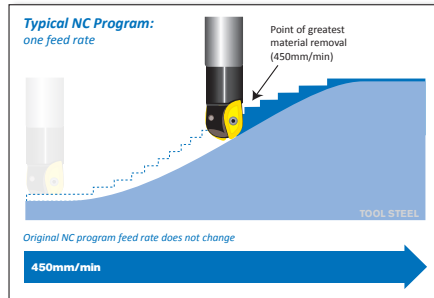

“...the result of using the optimization feature is a savings of more than 81 hours on one job alone.”

*Ben Miller
Tool & Die Programmer,
Parker Hannifin Corporation*

Machine More Efficiently...

Cut more parts in the same amount of time – it's like getting a free CNC machine! Reducing cycle time increases productivity and gets parts to market faster.

Save Money...

Increased productivity by reducing the time it takes to cut parts can add up to significant annual savings.

Improve Part Quality...

Constant cutting pressure causes little or no variation in cutter deflection. Finishes on corners, edges, and blend areas are better so less bench work is required.

Make Cutters Last Longer...

Optimum cutting conditions prolong tool life. Shorter machining times mean less cutter wear, so you change tools or inserts less frequently.

Reduce Machine Wear...

A more constant cutting pressure between the machine tool and the workpiece reduces variable forces on the axis motors for smoother machine operation.

Make Better Use of Time...

Machinists don't have to be glued to the feed rate override! They can run multiple machines, set up the next job, or attend to other duties.

Could You Benefit from OptiPath?

Do any of the following sound familiar? If so, OptiPath can help!

- Removing a lot of material
- Long machining times
- Large NC programs
- Interrupted cuts (multiple entry/exit)
- Cutting at variable depths/widths
- High speed machining
- Thin wall machining
- Delicate tooling and materials
- Expensive tooling and materials
- Hard materials, soft materials
- Older equipment
- Multiple parts
- Premature cutter wear/failure
- Optimizing programs “by ear”
- Reworking programs for feeds/speeds... or no time to do so
- CAM system and/or programmers don't have necessary knowledge
- “Resident expert” retiring/leaving
- Poor surface finish
- Excessive bench time
- Chip thinning problems
- Cutter deflection problems
- Chatter in corners
- Air cuts or light cuts at slow or programmed feed rates

Feed Rate=MAX

High Speed vs. High Efficiency Machining

The traditional method of high-speed machining, cutting at high feed rates with very shallow cuts and small step-over, can actually defeat the goal of reducing machining time! Cutting at greater depths removes material more efficiently. But, the cutter may encounter an overloaded condition causing it to break or exceed the machine's horsepower. Since OptiPath knows the amount of material removed, it adjusts feed rates accordingly and maintains a consistent chip thickness. This provides more efficient machining while protecting the machine and cutter.

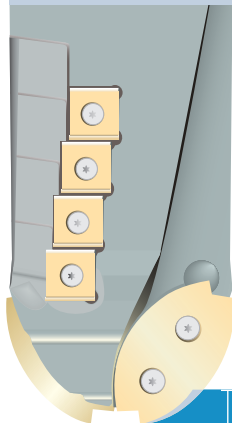

8mm CUT DEPTH

Excess material that could break cutter

TOOL STEEL

CNC Machine Probing

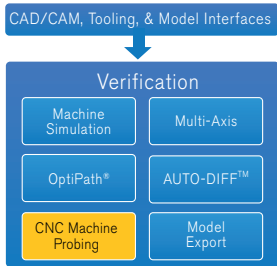

Create & Simulate CNC Probe Programs with VERICUT!

VERICUT is an ideal place to create probing sequences in a CNC program because of its 'in-process' model. This in-process feature geometry is not available anywhere else in the CNC manufacturing process.

Any number of errors can occur that will likely result in a broken inspection probe when using a CNC machine to perform probing operations. The probe tip/stem could contact another object while not in probe mode. The probe body or other machine component could hit something when moving. Or, an error in the probe cycle logic could cause unexpected machine motion – which could crash the machine, destroy the probe body,

5. Probe motions are simulated prior to being sent to CNC machine

4. G-code output

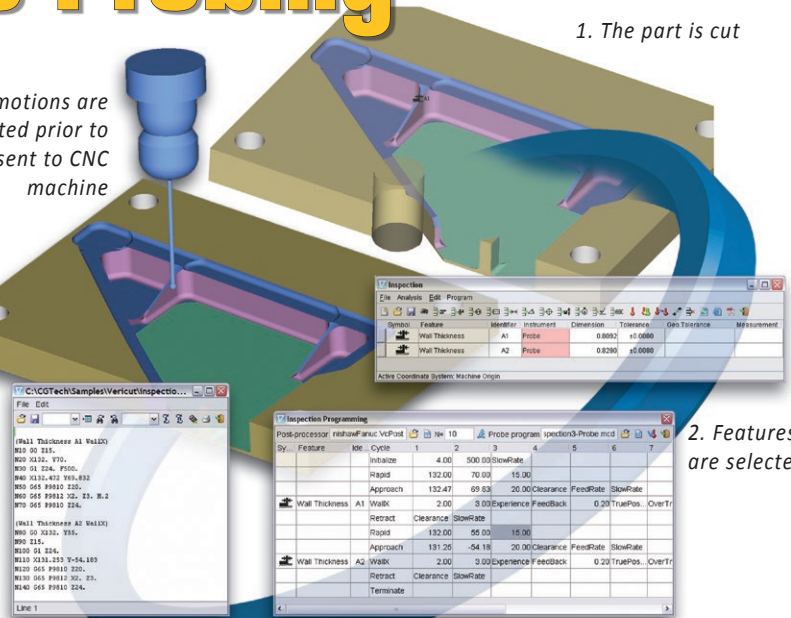

1. The part is cut

2. Features are selected

3. Parameters are set (post processor, cycle types, tolerances, etc.)

or break the probe tip.

With VERICUT simulation, there is no reason creating your probing operations should ever cause a headache. VERICUT notifies you when the probe tip contacts an object while not in 'probe mode,' and detects any collisions. By emulating the probe cycle's logic (which may alter machine motion based on information

gathered during probing), VERICUT helps protect probes and probe tips that could be damaged or broken by programming errors.

VERICUT simulates probe cycle subroutines or sub-programs, including complex logic and Type II formats used to set offsets and make decisions based on probe results. CNC Machine Probing will help ensure that you will not destroy the probe or crash the machine during tasks such as:

- Locating the stock and/or fixture and adjusting offsets
- Measuring and adjusting for stock variations
- Identifying stock and/or fixture configuration or part number
- Measuring and adjusting tool or fixture offsets
- Simulating tool check cycles
- Inspecting machined features

Contact CGTech to learn how VERICUT can create and simulate your custom probe cycles!

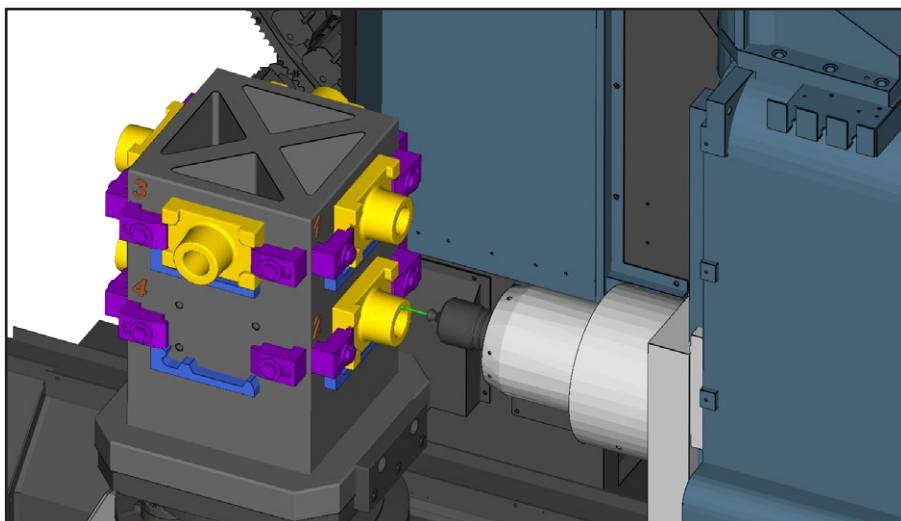

VERICUT simulates probe cycle subroutines or sub-programs used to set offsets and make decisions based on probe results.

Model Export

With Model Export, you can create CAD models of the cut part from your NC data at any stage of the machining process, complete with machined features.

VERICUT can be used to create a CAD model from an existing NC program. The model includes features such as holes, fillets, corner radii, pocket floors and walls – just as it's cut on the machine.

- Export a CAD model at any stage in the machining process
- IGES and STL output
- CATIA V5, CATIA V4, STEP and ACIS output with an optional Model Interface (not included with Model Export.)

Make Legacy Data Useful:

- Create CAD models from old G-code or APT programs

Perfect Offset Surfaces

Offset surfaces can be created using a CAD program, but this creates undesirable gaps and overlaps that require extensive model clean-up.

Model Export can be used to generate a CAD model without gaps or overlaps!

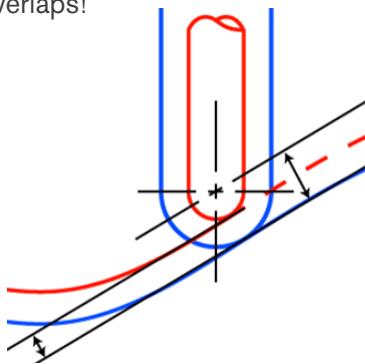

Running the original NC program with a smaller ball nose end mill automatically creates an offset surface.

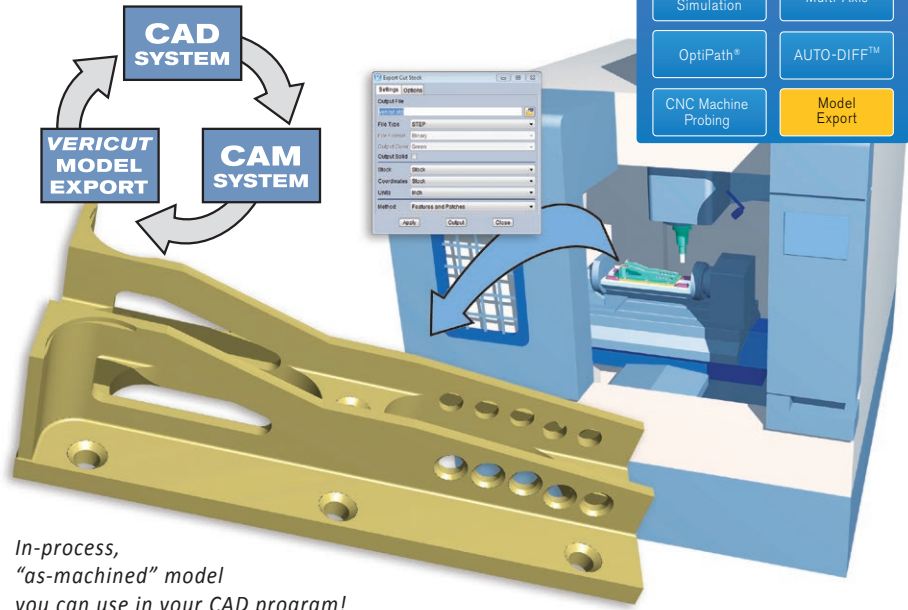

In-process, "as-machined" model you can use in your CAD program!

Improve Process Planning:

- Plan for multiple setups or staged machining

Improve Reverse Engineering:

- Take the "as-machined" model back into your CAD system

Create Fillets Automatically

VERICUT's cut stock exactly matches the finished part, including any fillets. The size of the ball nose end mill determines the fillet radius. Model Export will export a CAD model that includes all fillets.

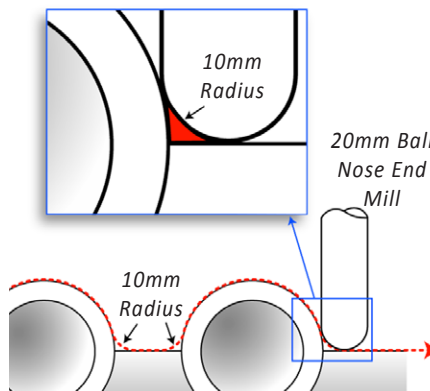

Exported CAD model includes all fillets. Fillet size is determined by the end mill radius.

In-process stock model

Large or complex models may require several setups. Model Export can be used to export a CAD model after each setup, providing programmers with a starting point for subsequent operations.

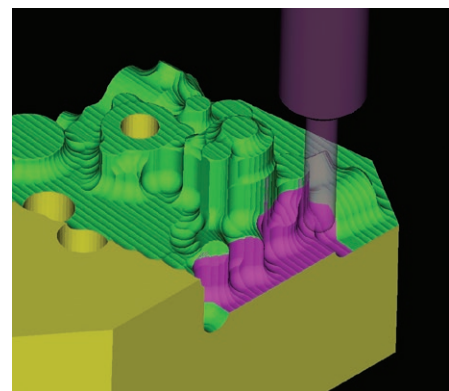

An exported in-process model provides a starting point for subsequent operations.

CAD/CAM & Other Interfaces

Integrate VERICUT and your CAM system(s) to easily create the most accurate and efficient NC programs possible!

CAD/CAM, Tooling, & Model Interfaces

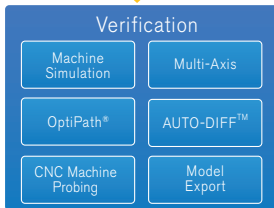

The interfaces make verifying and optimizing NC programs, and simulating CNC machines, a much easier and more efficient process. With most interfaces you can verify individual operations, or a series of operations.

All stock, fixture, and design geometry is automatically transferred to VERICUT in the correct orientation, along with your NC program, tooling, machine and control data, and other simulation parameters. VERICUT runs

independently, so you can continue working in your CAM system while simulating your NC programs. You can also import NC programs from other CAM systems in CL or post-processed G-code format.

The following CAD/CAM interfaces are available directly from CGTech:



Other interfaces available:



(from Open Mind)



(from Delcam)



(from Missler)



(from Delcam)



(from COSCOM)



(from SolidCAM)



(from SolidCAM)



(from Cimatron)



(from CGS)



(from Schütte)



(from Geometric)



(from NCG Cam Solutions)

Tool Management Interfaces extract tool lists from your tool manager system and creates VERICUT tool

assemblies. It is an on-the-fly live connection to your tool manager.



Model Interfaces enable VERICUT to read the designated model file formats and use them as stock, fixture, design, tool holder, and machine models. When combined with Model Export, VERICUT's cut stock may be written out in these formats as well. VERICUT includes

the ability to use several industry-standard model file formats: STL, IGES, VDA-FS, DXF, and NX (with NX Interface). Optional model interface modules allow VERICUT to use these additional formats: STEP, ACIS, CATIA V4, and CATIA V5.

Make VERICUT Work For You

It's Easy to Implement VERICUT Quickly to Capitalize On Your Investment

Obtain the full value of your VERICUT investment by integrating it into your existing manufacturing process. CGTech's sales, technical, and development staff have significant NC machining expertise. We know how to help you get the most from VERICUT in your manufacturing environment.

We will meet with your management to establish clearly defined goals. Then we will help determine how you can get up and running with VERICUT as quickly as possible using: VERICUT training, Customized VERICUT Machine Configurations (VMCs), and an implementation plan



tailored to your specific requirements. For a new customer purchasing one VMC, we may recommend two days of on-site training and one day of implementation.

"Just wanted to let you know I verified and optimized my first part Monday afternoon. The interface worked great and was a huge time savings. I was able to optimize the NC file for a 38.98% improvement in cycle time. The boss is very happy and we are looking forward to using this new tool on everything. I have to say this was the best training course I've ever taken... very good job showing us a lot in short time."

Jon Matthews, Gibbs Machine Corp

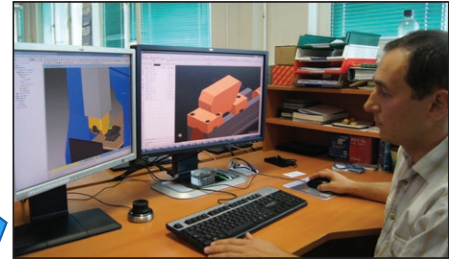

Jiri Machacek, NC Programmer at AERO Vodochody, uses VERICUT to improve machining efficiency and ensure machine tool safety.

Three Steps to Run VERICUT:

1. Define your stock model

- Import from your CAD system or create it in VERICUT

2. Set up your tooling

- Tool setup wizards for milling tools and turrets
- Create any cutter shape
- Read cutter descriptions from the tool path file
- Import CAD solid models
- Import via CAD/CAM or tool management interface

3. Import your NC program

- G-code
- CAM files (APT)

Then press cut. It's that simple!

Do you know how much prove-outs are costing you?

In today's competitive manufacturing environment, software verification is essential to your ability to produce on-time, high quality goods at a reasonable cost. In the conservative example to the right, prove-outs cost \$24,000 a month. This does not factor in additional costs such as scrapped or damaged parts, broken tooling, damaged fixtures, and extra machine tool maintenance. What are prove-outs costing you?

x	12	Number of machines
x	10	Hours per day
x	20	Days per month
x	0.10	% of time proving programs
=	240	Hours spent
x	\$100	Hourly machine cost
=	\$24,000	Monthly, or
=	\$288,000	annual prove-out cost

Services & Training

CGTech, and its global network of resellers, offer a host of consulting and training services

VERICUT training is offered regularly at numerous locations. Following are descriptions of training courses, implementation services, and consultancy that are available. For more information contact your CGTech representative or reseller.

Standard VERICUT Training

CGTech's hands-on training gives you the knowledge & skills to maximize VERICUT's potential. These courses are suited to NC programmers and CNC machine operators. After completing a course, you will be a better VERICUT user!

Machine & Control Building Training

VERICUT Machine & Control Building training is intended for experienced VERICUT users with a good working knowledge of VERICUT. The class builds on your existing knowledge as you learn techniques for configuring VERICUT Machine Configurations (VMCs) that can be utilized by all users at your company.

On-site or web-based VERICUT Training

Can't make it to a CGTech facility? Need customized training? We'll come to you! On-site or online training can raise your VERICUT skills to the next level and is a perfect complement to implement newly purchased VERICUT Machine Configurations (see "Contract Services" on the next page).

New Release Update Training

Improve your productivity with new VERICUT features quickly as a CGTech expert helps you learn how to apply them to your manufacturing processes.

Implementation Services:

Implementation & Automation Consulting

Get help integrating VERICUT into your manufacturing engineering and NC programming processes: both upstream CAD/CAM systems and downstream shop-floor systems. Ensure that VERICUT fits into your electronic workflow as smoothly and efficiently as possible! On-site advice from a VERICUT expert while working on your initial VERICUT projects, eliminates false starts and confusion, and can be the key to accelerating your ROI.

VERICUT Audit

Are you using VERICUT to its full potential? Here's how to tell! A VERICUT expert comes to your site and evaluates your VERICUT use and provides you with a written report covering potential risks in your current operation and areas where you can achieve better results. We check your VERICUT installation and assess whether your staff is sufficiently trained.

OptiPath Mentoring

Make sure you take full advantage of VERICUT's optimization capabilities. We teach you how to optimize NC programs – using your parts, on your machines. We work with you to set up optimization libraries and fine-tune the results, including runs on your machines, so your operators can see for themselves how efficient the optimized programs are.

When you invest in VERICUT, you're teaming up with experts committed to helping you succeed with our technology. Our dedicated staff of trainers, support engineers, & developers are available to help you reach your NC manufacturing goals.



Contract Services:

VERICUT Machine Configuration

Hire CGTech to create VERICUT Machine Configurations (VMCs) of your exact equipment and make running simulations a “push-button” operation!

NC Program Optimization

Want to improve the quality and production rates of your NC machining? Send us your NC programs (G-code or APT), and we return faster, more efficient programs. This is an ideal solution for shops with limited time, manpower, or optimization expertise.

CAD Model Export

Need an accurate CAD representation of your machined part, mid-process, or at the end of the final operation? We convert your NC programs (G-code or APT) into an “as-machined” CAD model.

Custom Tool Libraries & Custom Software Development

We build VERICUT tool libraries from scratch or from your existing spreadsheets and databases. Do you need special capabilities not currently found in the software? We tailor the software to suit your specific needs!

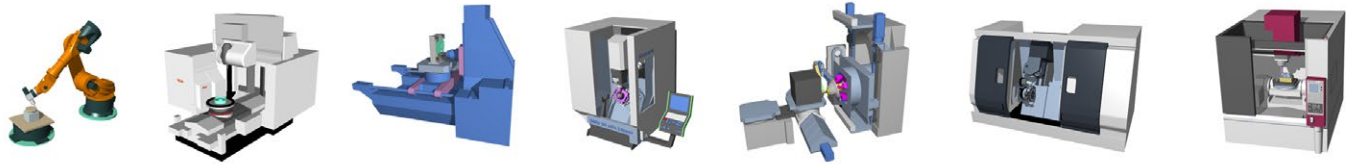

Configuring VERICUT to Simulate your CNC Machines

VERICUT Machine Configuration (VMC)

CGTech has an extensive collection of VMCs developed over several years for customers and with our machine tool partners. We maintain this collection, updating it for new VERICUT versions, features, and added machine and control functionality.

CAD models are only part of a working VMC. VERICUT also needs the control emulation logic and machine kinematics contained in the VMC. The VMC is configured to exactly match the Machine Tool options to ensure that your virtual machine and real machine behave identically.

Supplying VMCs

Each VMC requires some configuration to ensure it meets your exact machine specifications and options. This configuration is usually done by CGTech (or a VERICUT reseller). However, training can be provided to allow an experienced user to create and configure VMCs.

Your CGTech representative or reseller can work with you to provide a quotation for VMCs. They will discuss your requirements in detail in order to accurately determine the project scope. They will need to know the make and model of your machine(s), control type, special machine features beyond basic motion axes (tool changers, tailstocks, etc.) and control features. They will also make sure that the VMCs are delivered to your satisfaction.

Our Machine Tool Partners

CGTech has many years of experience creating and editing VMCs to meet the needs of its users. We are able to provide VMCs for machines from many of the leading Machine Tool Builders, often using CAD data supplied through our partnerships with these companies.

Our Machine Tool partners include DMG, Mazak, Mori-Seiki, Matsuura, Makino, Chiron, Hermle, Doosan, and many more. Machine Tool brands we have built VMCs for, include:



VERICUT Drilling & Fastening

VERICUT Drilling & Fastening (VDAF) is a software application for simulating and programming auto-drilling & fastening machines. VDAF is independent of both the machine and CAD system.

CAD/CAM, Tooling, & Model Interfaces



When working with expensive airframe assemblies, the cost of drilling or fastening mistakes is high! How much time do you spend avoiding them?

Visualize and simulate CNC drilling and fastening machines using the same NC program code that will be run on the machine. Simulation is independent from programming, and VDAF can simulate NC programs from any programming system for any CNC-automated drilling and fastening machine.

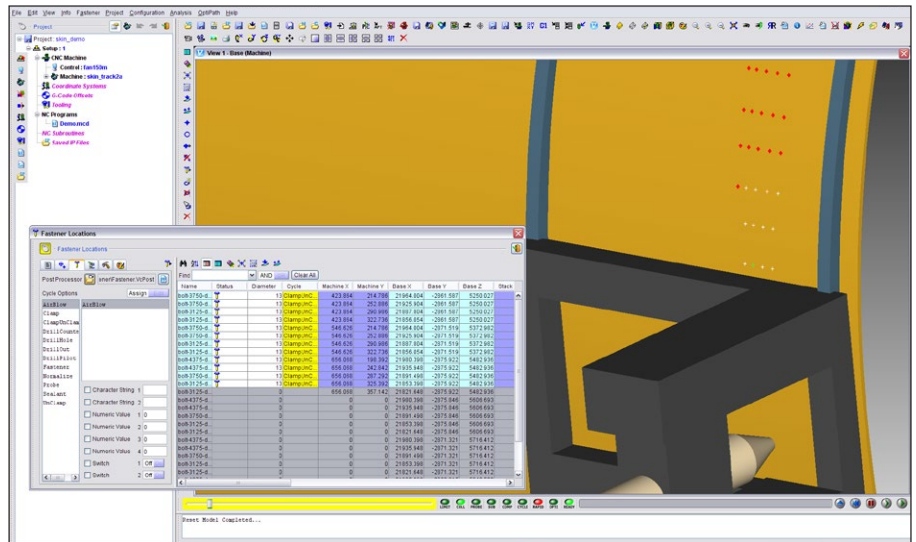

VDAF's programming option adds a user-friendly interface for creating CNC auto-drilling and fastening NC programs.

The VDAF Programming Add-on module to VDAF gives you the ability to create NC programs for CNC auto-drilling and fastening machines. Fasteners are displayed in a tree dialog that allows you to group fastener types under tree branches and order them as needed.

VERICUT Drilling & Fastening (VDAF) can help you avoid problems such as:

- Drilled hole or fastener in wrong position
- Missed hole or fastener
- Wrong hole size or fastener in right position
- Hole not drilled through the stack
- Hole double-drilled or double-filled
- Wrong fastener for material stack
- Collision with structure
- Collision with tooling
- Collision with added fasteners

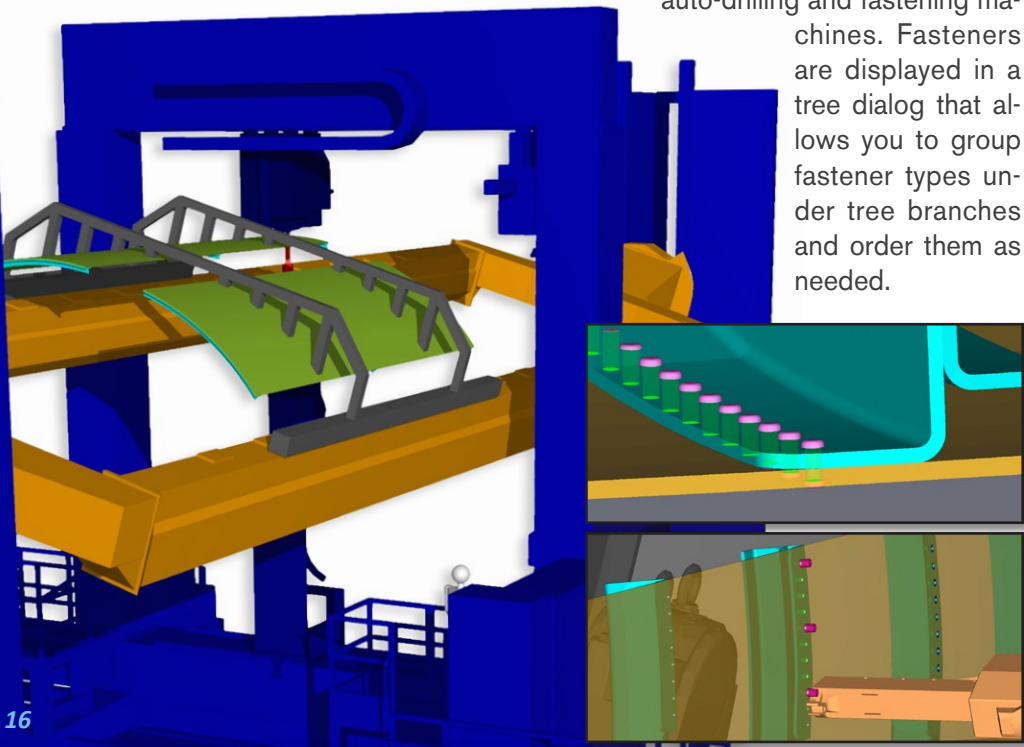

VERICUT Drilling & Fastening is based on industry leading VERICUT Software. VDAF is designed to create and simulate NC programs for automatic drilling and fastening machines, also called “layer drilling” or “riveting” machines.

Product Descriptions

VDAF Simulation

The base simulation software is used to visualize and simulate drilling and fastening from NC program code. VDAF simulation is a univer-

sal software application capable of simulating multiple CNC auto-drilling or auto-fastening machines. A single license can simulate multiple different machines using a VERICUT Machine Configuration (VMC) configured for each machine. Every VDAF implementation requires at least one VMC.

VDAF simulates machine motion directly from NC program files to check for collisions and other potential process problems. VDAF simulation also checks specific auto-driller/fastener actions, such as: proper drilling and fastening through the stack, appropriate tool selection for specified hole or fastener parameters, properly inserted fastener for given hole and stack call-out, and collisions with inserted fasteners.

VDAF Programming Add-on Option

This add-on module to VDAF Simulation creates NC programs for automatic drilling and fastening. This is a universal software application capable of programming many CNC auto-driller/fastener machines. A

single license can program multiple different machines using a post-processor configured for each machine.

The assembly to be programmed within VDAF contains an individual part model for each member of the CAD assembly, located in its proper assembled position. Each part’s material is identified, as well as the clamp surface and any fixturing. VDAF’s fastener locations are created from the CAD model’s fastener locations and attributes, as read by the custom-tailored fastener reader utility. Fastener locations contain the attributes of a fastener and its location in the assembly. The set of fasteners and their attributes define the drill and fastener cycles to be used.

One or more reference locations may be selected, typically at Drilled at Assembly (DA) holes or temporary fastener locations. These selections invoke machine reference operations, but typically do not affect nominal locations in the NC program. Hole or fastener locations are grouped by lo-

cal and global reference locations. Designating and activating reference holes create commands in the NC program to align the operation to the physical part.

The VDAF Programming Add-on Option requires a VDAF Simulation base license.

Post-processor

The post-processor formats the auto-drilling / fastening paths created in VERICUT for a specific machine. The post-processor contains the definition of all drilling, fastening, utility cycles, and functions used in the NC program.

Other Options

CATIA V5 Model Interface

Reads CATIA V5 native assembly files (.CATProduct) into VDAF Simulation and Programming.

Custom Fastener Object Reader

A custom script running inside the CAD system that reads user-defined fastener information and converts it into a VERICUT fastener file, in preparation for programming and simulation. This script is custom-written for each end-user implementation.

Vistagy SyncroFIT Interface

A standard interface for reading the assembly, fastener definition, and process information from SyncroFIT’s Airframe Design Environment, and prepares files for programming and simulation in VDAF.

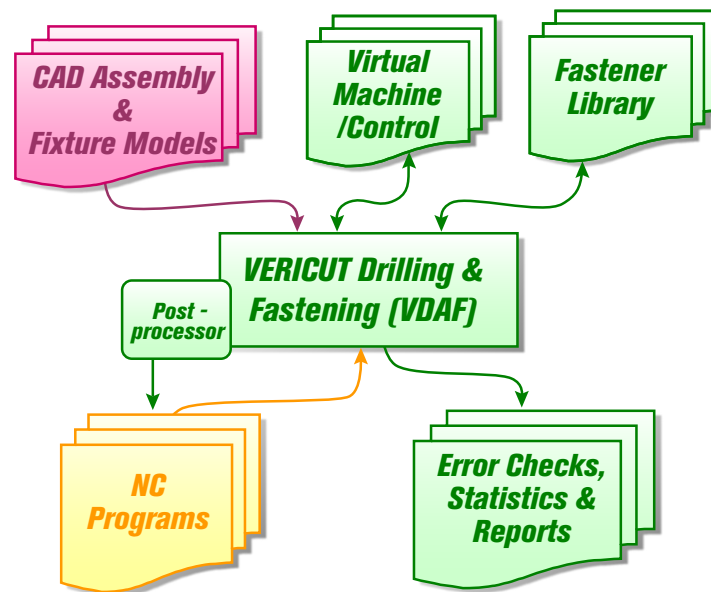

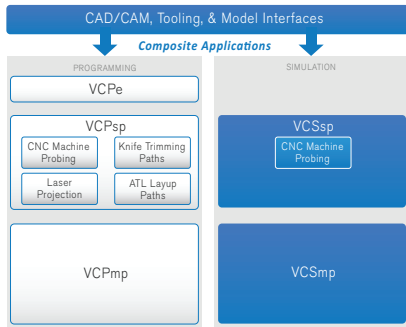

Composite Applications

Programming & Simulation Software for Automated Fiber-Placement (AFP) and Tape-Laying Machines (ATL)

VERICUT Composite Paths for Engineering (VCPe)

VCPe gives a composite part designer, mechanical engineer or process engineer access to the same software tools NC programmers use to create Automated Fiber Placement (AFP) NC program paths that are subsequently used in the workshop to lay-up a composite part. Using these tools the part designer or engineer can easily create and experiment with various AFP path options and evaluate the effects AFP manufacturing has

on a composite part's design intent. By producing actual AFP tape courses that could be used to program AFP fabrication equipment in the workshop, the user can measure and evaluate the effects of AFP path trajectory, material steering, surface curvature, course convergence and other process constraints as they would be applied in manufacturing. Tape course geometry can be written to various CAD formats for further evaluation by the user's existing analysis methods and tools.

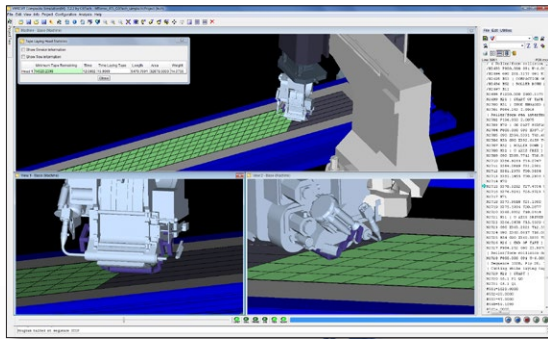

VERICUT Composite Programming (VCP) & Simulation (VCS)

VCP reads CAD surfaces and ply boundary information and adds material to fill the plies according to user-specified manufacturing standards and requirements. Layup paths are then linked together to form specific layup sequences and are output as NC programs for the automated layup machine. VCP can be used to program any number of machines, and includes support for probing, knife trimming paths, laser projection, and automated tape laying machines (ATL). VCP is also offered for a single platform (VCPsp) with optional modules.

VCS reads CAD models and NC programs, either from VCP or other composite layup path-generation applications, and simulates the sequence of NC programs on a virtual machine. Material is applied to the layup form via NC program instructions in a virtual CNC simulation environment. The simulated material applied to the form can be measured and inspected to ensure the NC program follows manufacturing standards and requirements. A report showing simulation results and statistical information can be created automatically. VCS can be used to simulate any number of machines, and includes support for probing. VCS is also offered for a single platform (VCSsp) with probing optional.

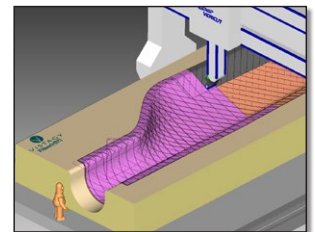
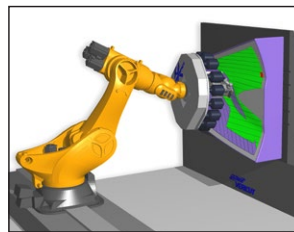
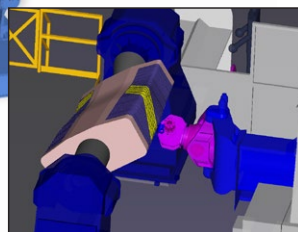
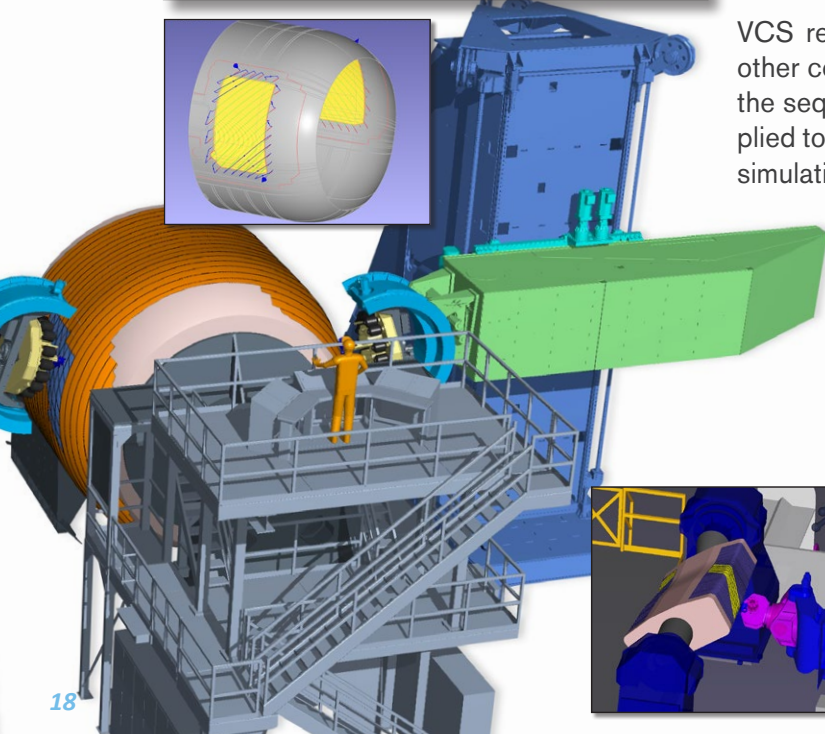

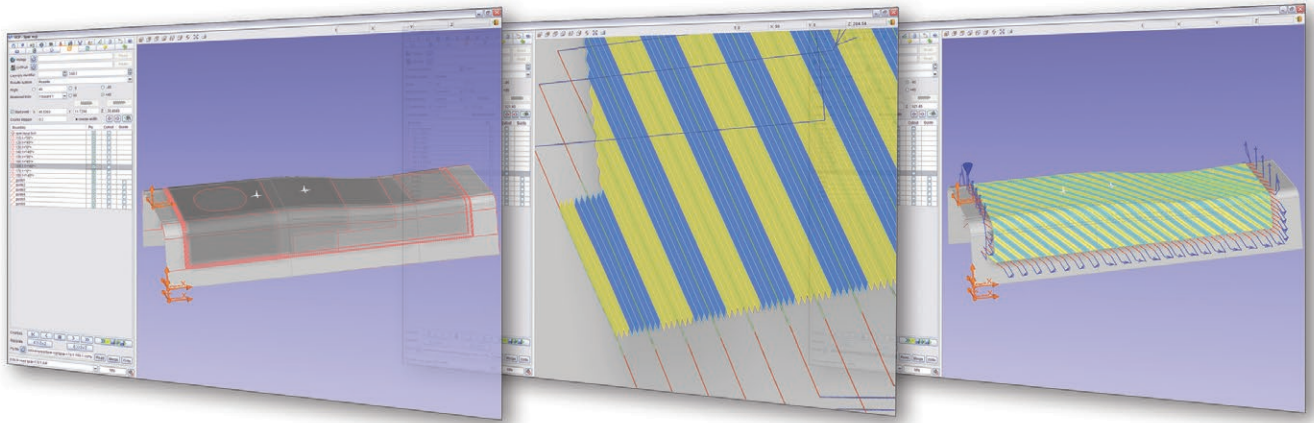

VCP Process Features:

Reads CATIA V5, NX, STEP, or ACIS surface models

- Other model formats available upon request

Reads Fibersim, CATIA V5, or other external ply geometry and information

- Boundary geometry
- Ply direction
- Start points

Generates layup paths based on manufacturing engineering rules

- Rosette projection at specified angles
- Parallel to guiding curve
- Follows the natural path of the form's surface

Add thickness to form for subsequent sequences

Links paths to create form layup sequences

- Automatic and manual linkage of paths based on shortest distance and form's topology
- Insert machine-specific commands and actions
- Insert safe start and restart events

Post-processes linked paths

- Output per machine requirements
- Configure machine-specific events
- Output safe start and restart sequences

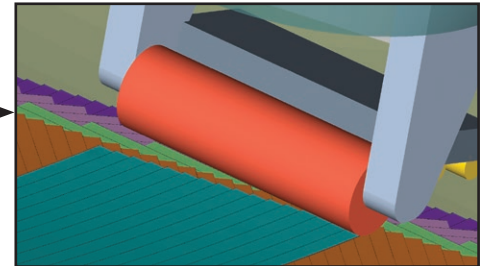
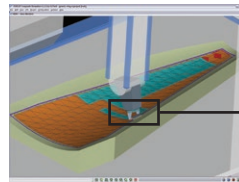

VCS Analysis Features:

Reads CAD geometry of the layup form

- Used for collision detection and material application

Uses VERICUT virtual machine and control emulation to simulate the layup machinery

- Can be configured for virtually any CNC syntax and machine kinematics configuration

Reads the NC program and simulates the layup process based on NC program commands

- Validate the actual NC program that will run on the layup equipment
- Add material to the form based on NC program commands
- Material is added in discrete layers/sequences, constructing the workpiece exactly like the physical process

Checks the process for compaction roller/form conformance and direction

- Verify roller orientation to path
- Verify path correctness to the form and previously applied sequences/layers of material
- Check roller conformance for bridging or excessive compaction

Added material is measurable and can be inspected for manufacturing requirements

- Measure lap, gap, and thickness
- Detect steering radius violations

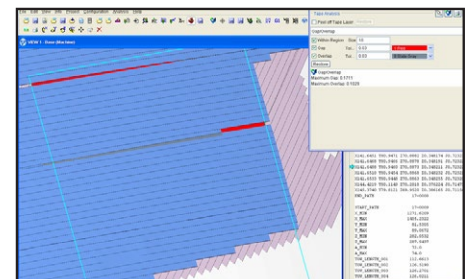



United States – Corporate Headquarters
 9000 Research Drive Irvine, California 92618
 TEL +1 (949) 753-1050 • FAX +1 (949) 753-1053
 info@cgtech.com

United Kingdom
 CGTech, Ltd.
 Curtis House, 34 Third Avenue
 Hove, East Sussex, BN3 2PD
 TEL +44 (0) 1273-773538
 FAX +44 (0) 1273-721688
 info.uk@cgtech.com

France
 CGTech S.A.R.L.
 Les Passerelles
 104 avenue Albert 1er
 92500 Rueil-Malmaison
 TEL +33 (0)1 41-96-88-50
 FAX +33 (0)1 41-96-88-51
 info.france@cgtech.com

Brazil
 CGTech Brazil
 Rua Serra de Botucatu, 22 Altos
 03317-000 Tatuapé
 São Paulo SP
 TEL +55 11 4119-0907
 info.brazil@cgtech.com

Germany
 CGTech Deutschland GmbH
 Neusser Landstr. 384
 D-50769 Cologne
 TEL +49 (0) 221-97996-0
 FAX +49 (0) 221-97996-28
 info.de@cgtech.com

Italy
 CGTech s.r.l.
 Viale Verdi, 1
 31100 Treviso
 TEL +39 (0422) 583915
 FAX +39 (0422) 543464
 info.italia@cgtech.com

India
 CGTech India
 # 38, 1st Main, 3rd Cross
 Malagala, Krishnananda Nagar
 New Outer Ring Road
 Bengaluru, 560091
 TEL +91 080 23 18 69 81
 info.india@cgtech.com

Japan
 CGTech Japan
 3F ERG Bldg. 1-5-3,
 Nishi-Ikebukuro, Toshima-ku
 Tokyo 171-0021
 TEL +81 (3) 5911-4688
 FAX +81 (3) 5911-4689
 info.japan@cgtech.com

China
 CGTech China
 Room 905, Raise Plaza,
 No.126 Jianguo Road,
 Chaoyang District, Beijing, 100022
 TEL (086) 10-6566 9919
 FAX (086) 10-6566 1538
 info.china@cgtech.com

Singapore
 CGTech Singapore
 PO Box 074
 Singapore 914003
 TEL +65 6638 6455
 info.ap@cgtech.com

CGTech® is the leader in CNC machine simulation, verification, and optimization software technology. Since 1988, our products have been the standard in manufacturing industry sectors including aerospace, automotive and ground transportation, mold and die, consumer products, power generation, and heavy industry. With subsidiary offices throughout Europe and Asia, and a global network of resellers,

CGTech software is used by companies of all sizes, universities, trade schools, and government agencies.

CGTech maintains an active Technology Partnership program. VERICUT users in this program include many of the world's leading machine builders, CAD/CAM developers, and manufacturing software companies.

When you invest in VERICUT, you're not just buying a software program, you're teaming up with a manufacturing partner with the best reputation in the business!

System requirements are subject to change. See the CGTech web site for the most up-to-date product information and system requirements.

© CGTech 2014. All rights reserved. CGTech, OptiPath, and VERICUT are registered trademarks of CGTech. AUTO-DIFF, X-Caliper, and CATV are trademarks of CGTech. All other trademarks are property of their respective owners. 1/2014