

An Introduction to

DESIGN FOR ADDITIVE MANUFACTURING

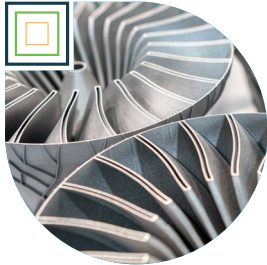

table of contents



This table of contents is **interactive**.
Please click for desired information.

DfAM Basics



What is additive manufacturing?

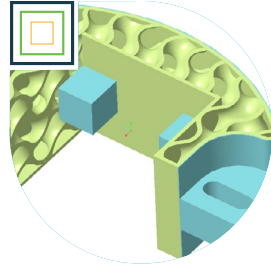

Design for additive manufacturing (DfAM)

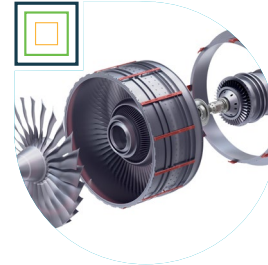

Increase competitiveness across the enterprise

Putting DfAM to Work

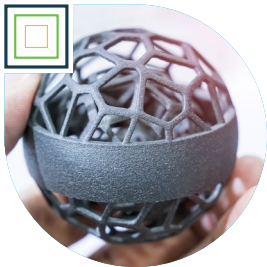

How to use additive manufacturing



Additive manufacturing maturity model

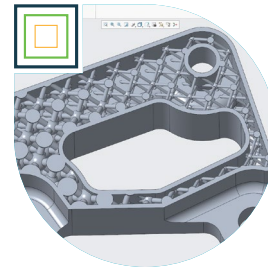

Making the most of lattices

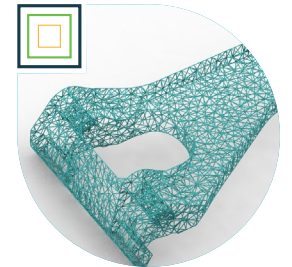

Advanced lattice construction

Taking the Next Step



How does AM work with CAD systems?

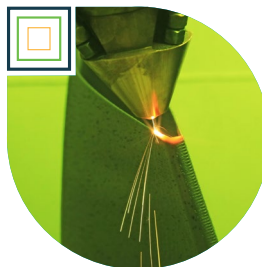

Metal printing

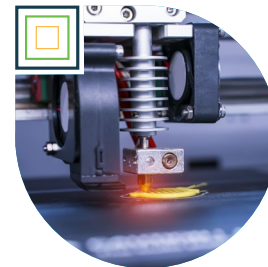

AM printer technology



What's next?



WHAT IS ADDITIVE MANUFACTURING?

This guide introduces design for additive manufacturing (DfAM) and offers an overview of its benefits, applications, the design process and integration with the CAD system. But what exactly is AM?

Additive manufacturing (AM) is the process of building up layers of material to create a physical model of a digital design, and it is typically associated with industrial and manufacturing applications.

Initially, AM was used to reproduce parts originally designed for traditional manufacturing processes. However, without the limitations of traditional manufacturing processes, products could be **designed for additive manufacturing (DfAM)**, with innovative shapes that couldn't be previously manufactured with castings or machining. Today, these technologies are often embedded in the conventional manufacturing process.

DfAM should be closely integrated into the CAD system, and it has implications for both product designers and executive management. Companies using AM in this fashion can design and produce innovative shapes unfettered by limitations of traditional manufacturing technologies or the need for multiple software packages and the resulting data translation hassle.

The additive manufacturing ecosystem goes beyond just hardware and software — although there is plenty of both. Consider the ecosystem associated with a fully integrated DfAM process.



DESIGN FOR ADDITIVE MANUFACTURING (DfAM)

How, exactly, do you design for AM in such a way as to take advantage of its benefits? AM is not a stand-in for traditional manufacturing methods. It's a new way of looking at product design. DfAM leverages the transformational power of AM to provide engineers and designers with the tools needed to achieve highly complex designs that break the barriers set by traditional manufacturing.

GET FAMILIAR WITH GENERATIVE DESIGN

Generative design is a tool that uses artificial intelligence (AI) to create product designs automatically based on your constraints and requirements – including material and manufacturing processes.

Generative and AM's combined capabilities can lead to faster development, higher quality, and ready-to-manufacture designs.

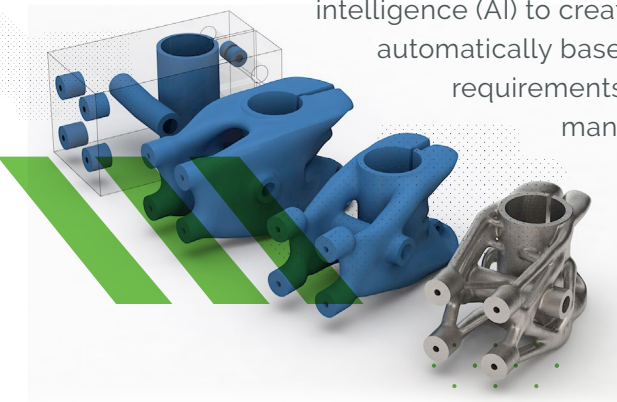

[LEARN MORE ABOUT CREO GENERATIVE DESIGN →](#)

CONSOLIDATE MULTIPLE PARTS INTO A SINGLE PART

The limitations of traditional manufacturing often require the assembly of multiple parts to accomplish design objectives. With additive manufacturing, you can consolidate multiple parts into one, reducing assembly costs and simplifying manufacturing procedures. DfAM also has the benefit of eliminating assembly errors, for better overall quality.

LEARN HOW TO USE LATTICES

Lattices are a quintessential part of DfAM, helping to improve flexibility, cost and weight in ways not possible with traditional manufacturing. Lattices can be made

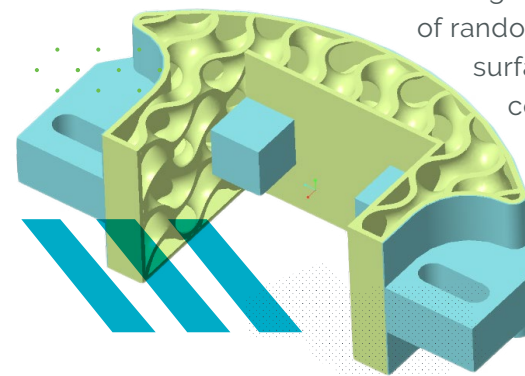

of random cells following the surface of a part, or they could fill the internal volume of a part.

They can even serve functional purposes such as heat exchange or shock absorption. Learn more about lattices on pages 8 and 9 below.

INCREASE COMPETITIVENESS ACROSS THE ENTERPRISE

DfAM is so appealing because there are many print technologies to allow for the layer-by-layer construction using materials from human cells to metal. But the beauty of DfAM is more than skin deep. The technology's real value is strategic, and the financial impacts appear in such key operating metrics as cost of goods sold, time to market, and inventory carrying costs.

1. OPERATIONS

Higher quality, lower costs, and innovative designs yield higher revenue and profitability.

2. ENGINEERING

Rapid prototyping, part consolidation, and high-performance designs.

3. SALES

Faster time-to-market with innovative, customized products.

4. MANUFACTURING

High-quality, low-cost production and reduced downtime.

5. SERVICE

Lower inventory carrying costs and production of legacy service parts.

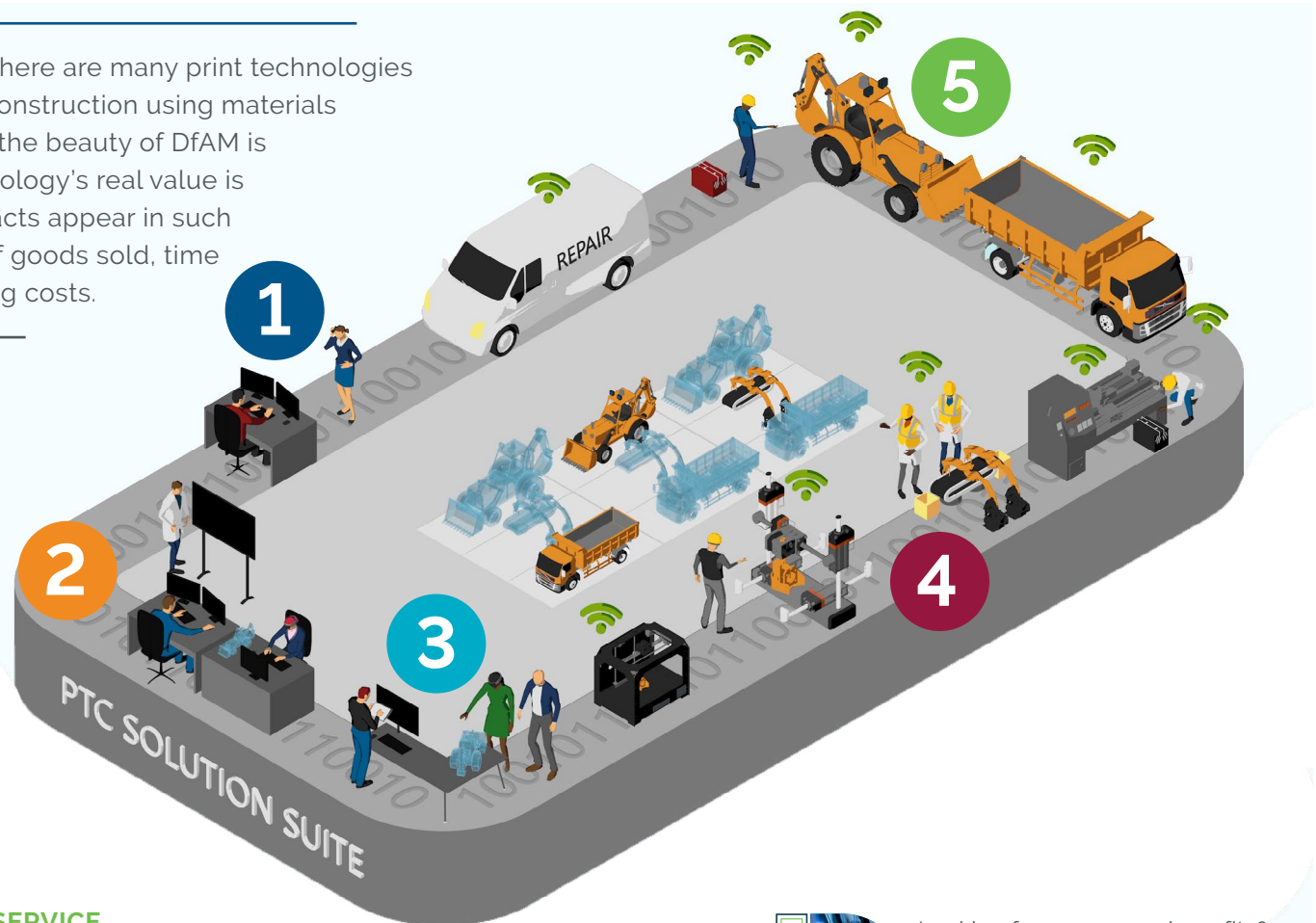

Looking for even more benefits? [Read Mike Gayette's article on Top Ten Advantages of Additive Manufacturing.](#)

HOW TO USE ADDITIVE MANUFACTURING

What can you do with the technology? One reasonable answer might be **"Whatever you want,"** simply because the very nature of AM makes for varied use cases. The small sampling of use cases below should give you a sense of AM's potential.

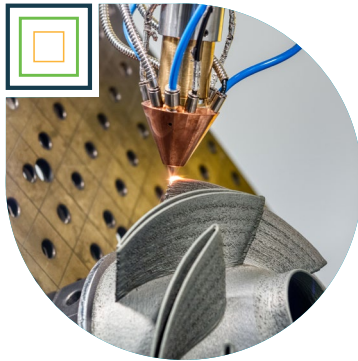

High-performance/
lightweight and part
consolidation



Tools/jigs/fixtures &
on-demand service
parts



Mass customization

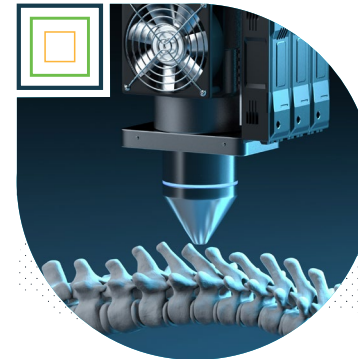

Customized,
precision parts

DESIGN FOR ADDITIVE MANUFACTURING MATURITY MODEL

A maturity model is a framework that helps companies benchmark themselves against others, to better understand where they are on their process journey from beginner to world-class. Consider it a map from starting point to desired final destination.

Getting started with DfAM is easier than you think, but it helps if your AM tool is fully integrated into your CAD system, to avoid the time and errors associated with using multiple software packages.

Many companies begin with prototypes for both customer reviews and design validation, often with polymer materials. AM can quickly benefit production teams by enabling rapid creation of tools, jigs and fixtures. As companies gain experience, they can apply AM to low-volume / high-value production parts, with both polymer and metal printing. More experienced companies transition to higher-volume production and, eventually, see AM as a key enabler of innovation.

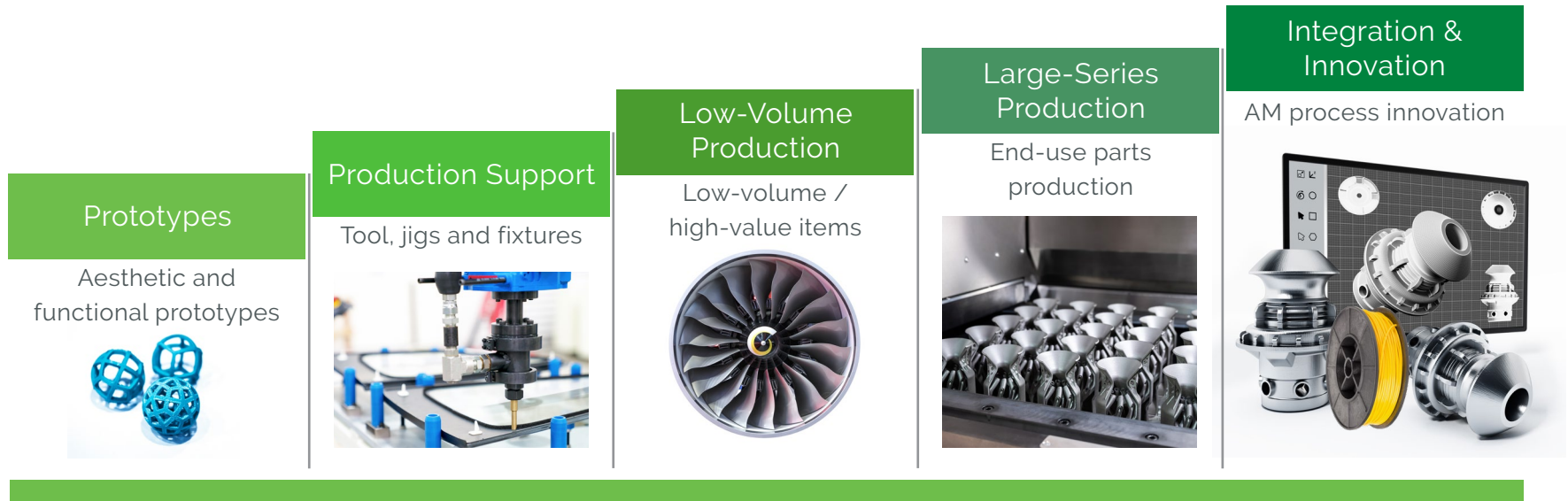



MAKE THE MOST OF LATTICES

Lattices are bio-inspired configurations based on repeating unit cells. Lattices improve strength-to-weight ratio, improve flexibility, and help to minimize cost. AM is ideally suited to designs with lattices, which come in an almost limitless variety, as shown below.

With Creo Additive Manufacturing Extension, you can leverage a database of advanced lattice structures, including custom-defined cells. Best of all, this capability is integrated directly within the Creo design environment.

Inspired by Nature

You can see lattices naturally occurring all around us.

2D Surface Lattices



Extruded (2 1/2 D) Lattices



3D Beam Lattices

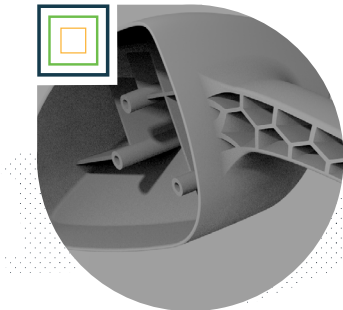

Extruded (2 1/2 D) Lattices

These lattices are created by extruding shapes, like triangles, squares, hexagons or octagons. Drain holes can be included to avoid trapped material. A honeycomb shape was used in the neck of this car mirror.

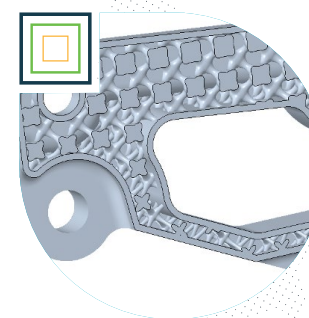

3D Beam Lattices

These lattices are created by interconnected beams to fill the volume of the part. The lattice cells can be uniformly distributed, randomized or custom created. Critical areas can be reinforced with thicker lattice beams, which can be transitioned in size to avoid and an abrupt change in lattice design.

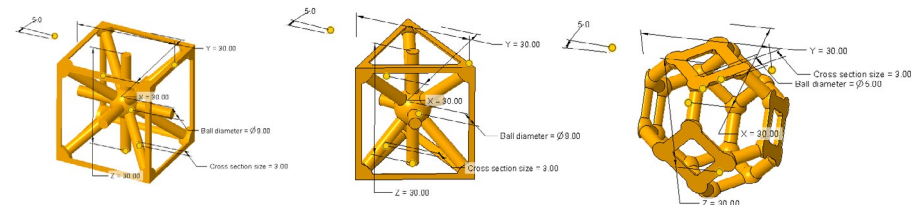
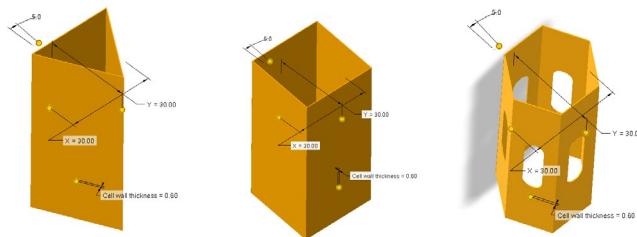

ADVANCED LATTICE CONSTRUCTION

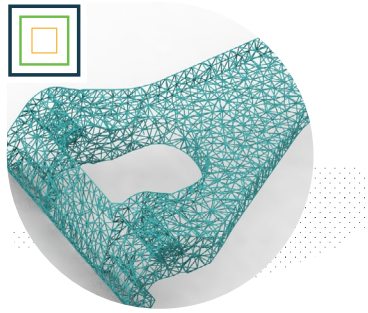

Conformal Lattices

These lattices are created by interconnected beams that conform with the shape of the part. They can be used throughout or just on the exterior, representing the "skin" of the part. These stochastic lattices are defined by a randomized cell that creates a foam-like material. Conformal lattices could be used in noise suppression, medical bone grafts and many other applications.

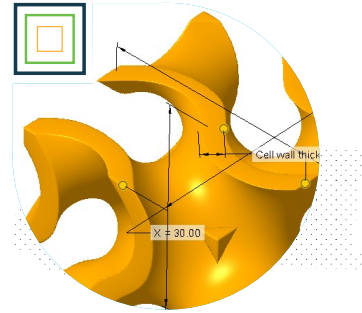
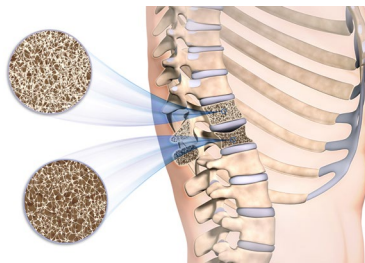

3D Surface Lattices

Sometimes referred to as formula-driven lattices, these "gyroids" are self-supporting, thereby eliminating post-processing activities and reducing material costs. These continuous surface cells can serve an additional functional purpose, such as shock absorption or thermal transfer.

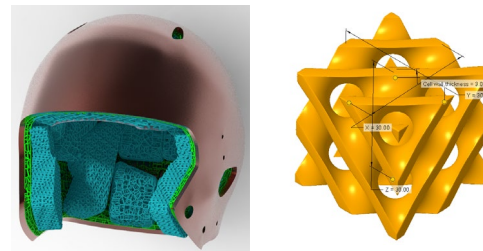
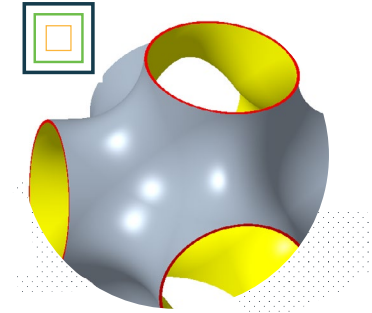
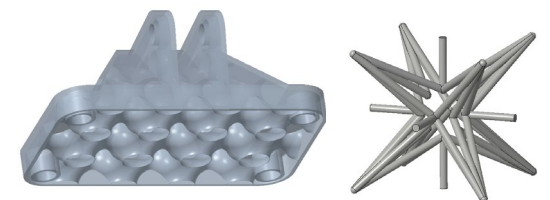

Image courtesy of Dr. Andreas Vlahinos



Custom Lattices

With Creo, you are not constrained by existing lattice choices. You can create your own lattice designs to help minimize internal stress concentrations. Or you might design a custom lattice to improve mechanical or thermal properties. The possibilities are limitless.



HOW DOES DfAM WORK WITH CAD SYSTEMS?

The additive manufacturing industry is somewhat fragmented in terms of vendors and standards across the different aspects of software and hardware. It isn't quite as simple as hitting the print button. To get the most out of AM, it really should be fully integrated into your CAD system. Otherwise, you may find yourself with a set of file import/export issues as tedious as they are time consuming. To see how this might unfold, see the inset to the right.

With PTC, you avoid this risk and frustration. The additive manufacturing tools are fully integrated into Creo. You can create lattice structures, run simulations, and prepare nested AM print files, without ever leaving the Creo design environment. Creo even has tools to help with specialty metal printing, as described on the next page.

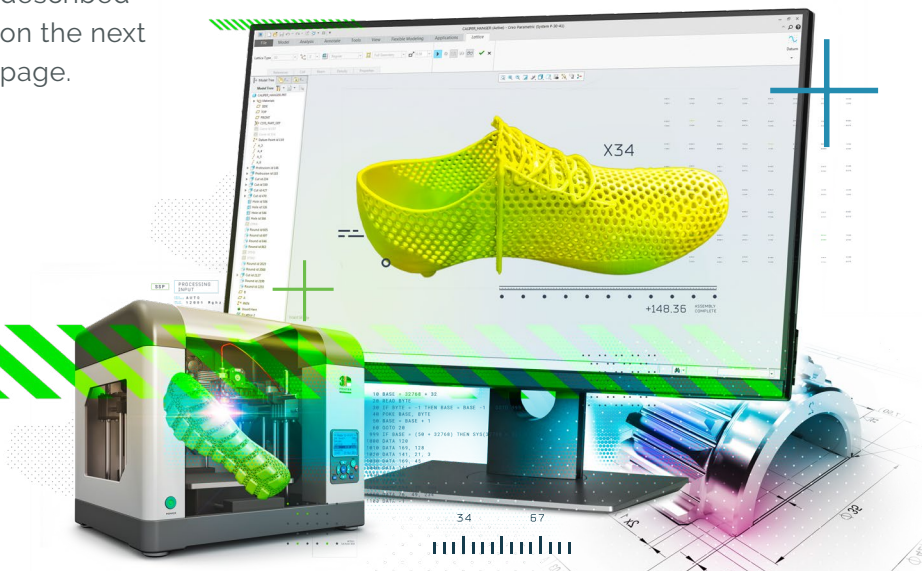

Do you really need 4 different types of software?



DESIGN

+



LATTICE CREATION

+



SIMULATION

+



FILE PREPARATION

=

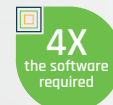

Your design has been created for additive manufacture, but your CAD system can't generate the desired lattice pattern.

You have to export your design to a software package for lattice creation, and then import it back into your CAD system.

To run a simulation to ensure that the part meets your strength and deflection requirements, you have to export the lattice design to a simulation software package, and iterate until your design meets all requirements. Then export the file back to your CAD system.

Now you need to prepare the design for AM printing, with required nesting and support structures. Again, you export that file to yet another software solution for print preparation.

This can lead to time consuming and error-prone processes between a broken chain of multiple software packages.

DfAM doesn't have to be this difficult - Creo's integrated tools make this much easier.

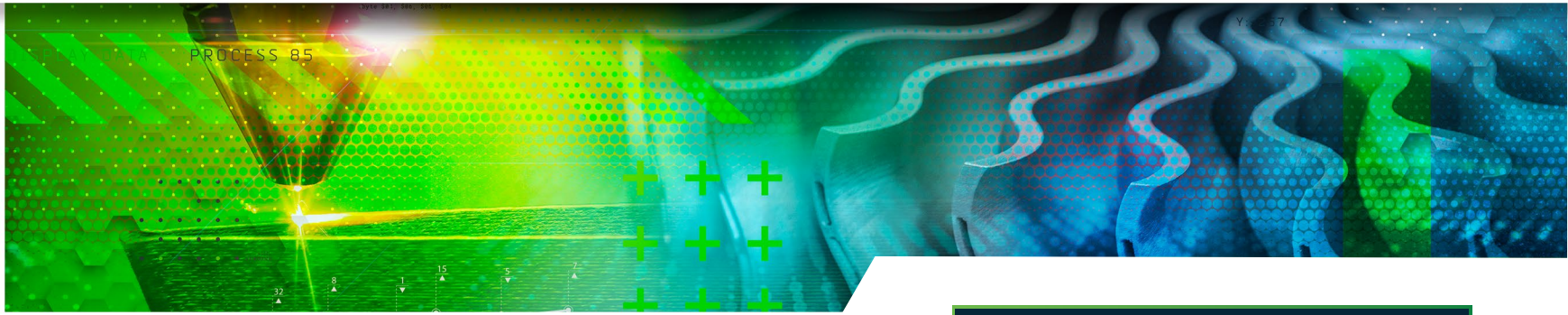

METAL PRINTING

[LEARN MORE ABOUT METAL PRINTING SIMULATION](#) →

At some point in your DfAM journey you will likely consider metal printing. How is this different from and similar to polymer printing? What extra challenges should you anticipate? Metal printing is not distinct from polymer printing, but it has its own distinct characteristics.

First the good news. You can metal print in a variety of materials, like aluminum, tool steel, titanium, and Inconel, to name a few. In addition, the mechanical properties are excellent in terms of corrosion resistance, strength-to-weight ratio, and bio-compatibility. And when original tooling is no longer available and you need a quick, short run of production parts, metal printing is a great option.

A big difference between polymer and metal printing is heat build-up and heat management. Thin walls can be difficult to produce with metal printing, and you may need to compensate for expected thermal distortion. And the support structures are even more critical for metal printing, as the metal parts are denser than polymer parts. Simply put, there is a learning curve for metal printing.

Fortunately, Creo can help get you up to speed quickly. Creo Additive Manufacturing Extension Advanced for Materialise is an optional extension that simplifies metal printing.

CREO ADDITIVE MANUFACTURING EXTENSION ADVANCED FOR MATERIALISE

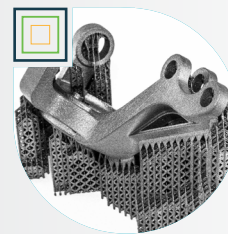

Now you can directly connect to a variety of metal printers, with automatically generated support structures using Materialise Magics. Creo can also help you optimize metal lattices and enable third party applications with standard APIs.



There are several fundamental printer technologies, each optimized for specific materials and desired outcomes. Fortunately, like the print drivers on your computer, Creo makes it easy to 3D print to a wide variety of brands and types of printers.

Additive Manufacturing Print Service Bureaus

The great news is that you don't have to invest in state-of-the-art printer technologies from the start. There are printer service bureaus that provide a wide array of on-demand printing for prototyping and end-use production, for both polymer and metal products. These service bureaus can also help with part design, print preparation, cost evaluation using instant quotes, and consulting services.

And with Creo, you can print to a variety of print bureaus, directly from the Creo design environment.

DIAGRAM KEY

Printer Type
(Materials)
Description



Visual
Representation

Common
Application

**Powder Bed Fusion
(Polymer and Metal)**
Thermal energy bonds layers from a material bed

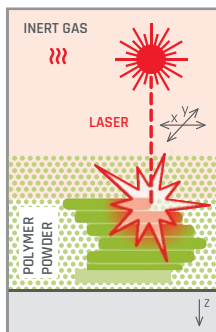

Functional parts

**Material Extrusion
(Polymer, Metal & Composite)**
Material dispensed through a nozzle

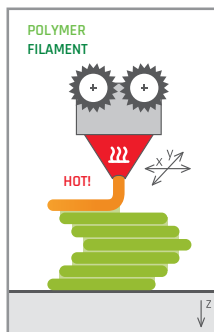

Inexpensive physical models

**Material Jetting
(Polymer, Metal & Composite)**
Droplets of material deposited and cured

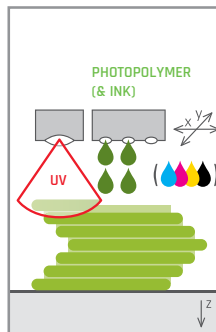

Multiple material properties and colors

**Photopolymerization
(Polymer)**
Liquid polymer cured by light

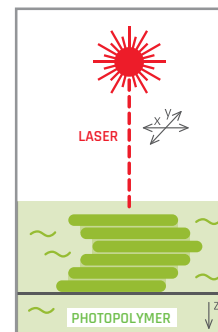

High-quality surface finish

**Dir. Energy Deposition
(Metal)**
Material is deposited and fused in place

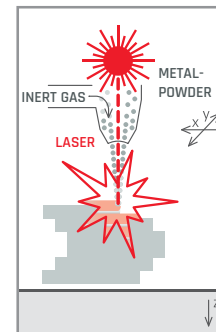

Large, metal products

**Binder Jetting
(Metal & Composite)**
Bonding agent joins power materials

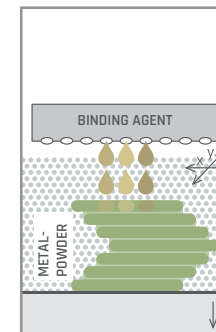

Low-cost, high-volume parts

**Sheet Lamination
(Composite)**
Sheets are cut and bonded

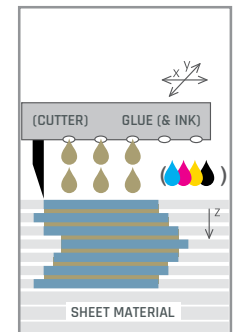

Mold-making applications



WHAT'S NEXT?

No matter where you are in your DfAM journey, PTC can help. We have tools that you can use for prototyping, manufacturing support, finished production and a full digital integration. Contact PTC and let us show you how we can assist.

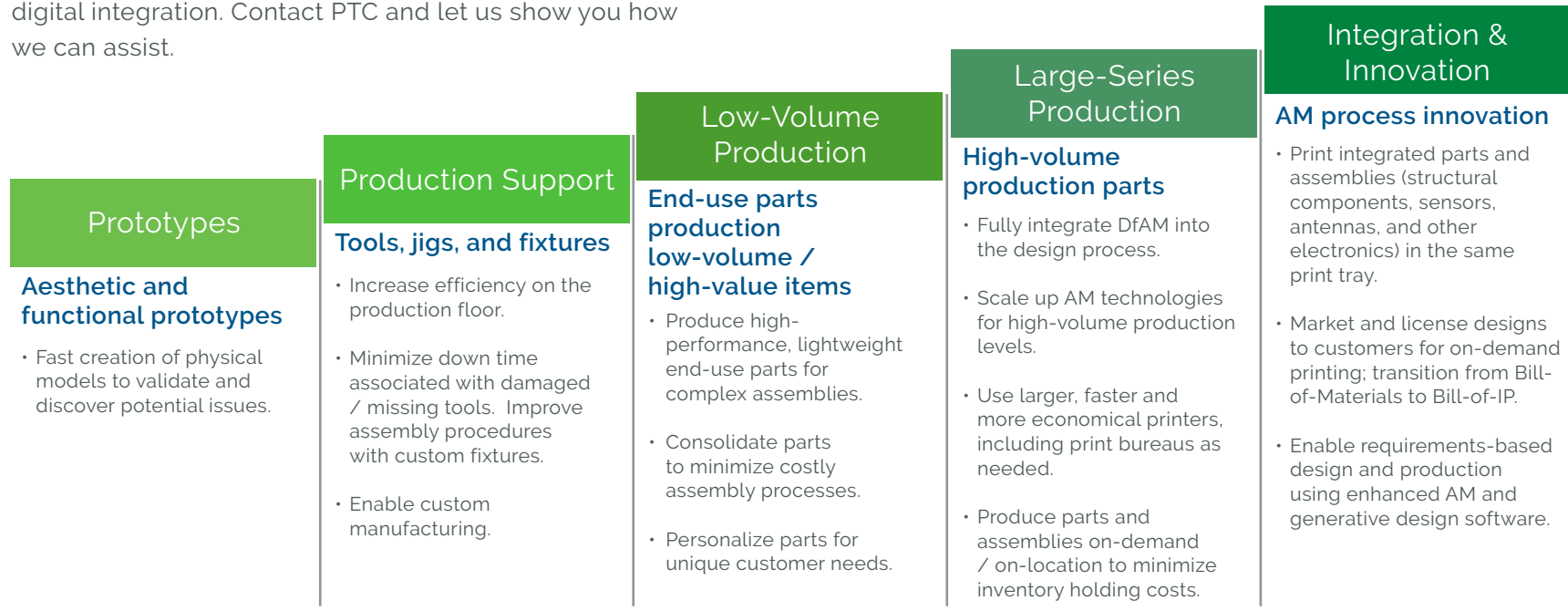

DESIGN FOR ADDITIVE MANUFACTURING MATURITY MODEL

[VIEW THE CREO AM BROCHURE →](#)[NEED MORE INFORMATION? →](#)[← BACK TO TABLE OF CONTENTS](#)

ACRONYMS

3DP - 3D Printing

3MF - 3D Manufacturing Format

AMF - Additive Manufacturing File Format

AMX - Creo Additive Manufacturing Extension

AMX Advanced - Creo Additive Manufacturing Advanced Extension for Materialise

CAD - Computer-Aided Design

CLI - Common Layer Interface

DfAM - Design for Additive Manufacturing

DMD - Direct Metal Deposition

DMLS - Direct Metal Laser Sintering

EBM - Electron Beam Manufacturing

FDM - Fused Deposition Modeling

FFF - Fused Filament Fabrication

PBF - Powder Bed Fusion

SLA - Stereolithography

SLS - Selective Laser Sintering

SLM - Selective Laser Melting

STL - Stereolithography/Standard Triangle Language/Standard Tessellation Language

© 2022, PTC Inc. All rights reserved. Information described herein is furnished for informational use only, is subject to change without notice, and should not be taken as a guarantee, commitment, condition or offer by PTC. PTC, the PTC logo, and all other PTC product names and logos are trademarks or registered trademarks of PTC and/or its subsidiaries in the United States and other countries. All other product or company names are property of their respective owners.

205809_Additive_Manufacturing_ebook_0722